

# Design and installation of the NCal reference plates for O4 VIR-1123A-21

Eddy Dangelser, Dimitri Estevez, Hubert Kocher, Marc Krauth, Benoit Mours,  
Mehmet Ozturk, Antoine Syx, Valeria Zeter

IPHC-Strasbourg

October 20, 2021

## Contents

<b>1</b>	<b>Introduction</b>	<b>1</b>
<b>2</b>	<b>Template design and expected accuracy</b>	<b>3</b>
<b>3</b>	<b>Precision of the measuring tapes used</b>	<b>4</b>
<b>4</b>	<b>Template testing at IPHC - 23 august 2021</b>	<b>4</b>
<b>5</b>	<b>On-site Assembly at VIRGO NE - October 5, 2021</b>	<b>6</b>
5.1	Preliminary measurements . . . . .	6
5.1.1	First set of measurements . . . . .	6
5.1.2	Second set of measurements . . . . .	6
5.1.3	Third set of measurements . . . . .	6
5.2	Overall results and uncertainties . . . . .	6
5.3	Additional measurements: supporting beams vs reference plates . . . . .	7

## 1 Introduction

In order to provide a better calibration of the Virgo interferometer, a Newtonian Calibrator system (NCal) is being developed. The NCal tests during O3 have shown the importance and difficulty to know the distance between the mirror and the NCal(s).

The O4 NCal design, described in [VIR-0391A-21](#), foresees the installation of three sets of NCals on the NE tower, one on the south side, at the location used during O3, one on the opposite side, called hereafter the north location, and one on the east side.

Figure 1 presents a CAD view of one of these setups that will be made of a suspended body, which could host up to three NCals, and a bottom part fixed on the tower based used as position reference system. The position of the suspended part, relative to the reference plates (in blue on figure 1), will be monitored using position sensors. The reference plates are installed on top of frames (in green on figure 1), attached to the tower base. The installation of these frames was made with a crude positioning, using the imperfect geometry of the tower base. The fine relative positioning of the three reference plates is using a mechanical template to provide well-defined relative distances in order to create a local referential for the NCal system, and compute the mirror position relative to it.

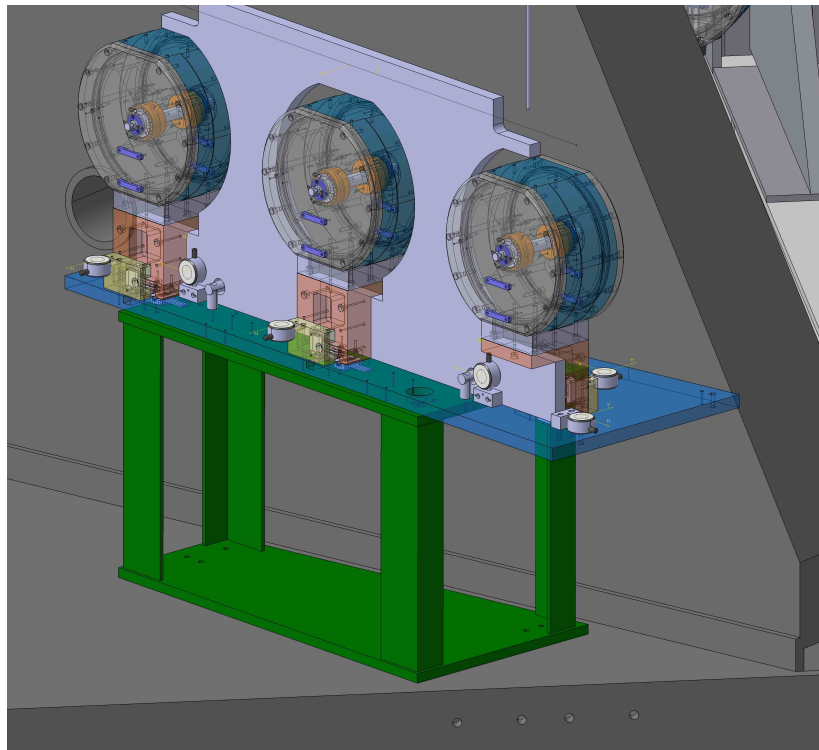

Figure 1: CAD view of the north NCal setup

The most important distance to know is the distance between the north and south reference plates, and especially the 10 mm H7 diameter reference hole located at the inner end of the reference plates and aligned on the expected axis of the NCal (see the drawings and the pin inside the yellow circle of figure 2).

This note describes the expected relative position accuracy of the reference plates as well as the measurements made during the tests at Strasbourg and the installation phase at the Virgo site. The mechanical drawings are included at the end of the note.

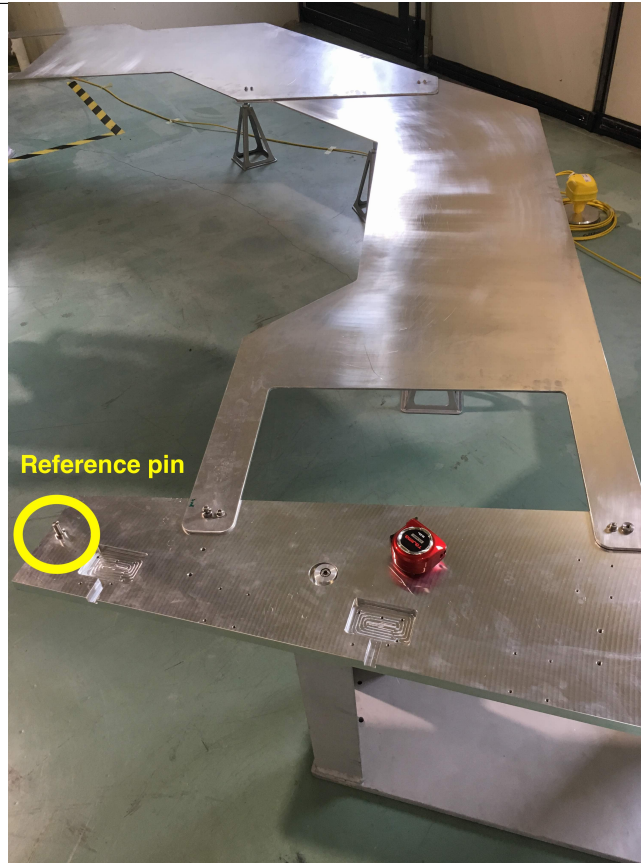

Figure 2: Blank assembly of the support, reference plate and template. The inner reference hole/pin is within the yellow circle.

## 2 Template design and expected accuracy

The template is made of four 5 mm aluminum plates of about 2 m long. Their size is a compromise between flexibility for the transport (smaller is better) and the precision (less parts is better) as well as the need to go through the tower ribs. The 10 mm diameter assembling holes have been drilled using a numerical control machine (having a range long enough) for the template parts and the reference plates.

The uncertainty on the assembling holes diameter is expected to be between 0 and  $+18 \mu\text{m}$  (H7 tolerance). The uncertainty on the pins diameter is between  $-15$  and  $0 \mu\text{m}$ . Therefore, the clearance for the pins assembly is between 0 and  $33 \mu\text{m}$ . This translate to a  $\text{rms} = 33/\sqrt{12} = 10 \mu\text{m}$  when assembling a pin. The uncertainty on the positioning of the assembling holes is expected to be less than  $20 \mu\text{m}$ , thanks to the use of the numerical control machine to drill them. To get the overall uncertainty on the relative positioning of two template part assembled with a pin, we add linearly (to be conservative) these two uncertainties and use  $30 \mu\text{m}$  hereafter.

Since the two pins of the east plate are 0.61 m apart, the accuracy on the angle made by the two template parts is typically  $30 \mu\text{m}/0.61 \text{ m} = 0.05 \text{ mrad}$ . To get an uncertainty on the position at the end of the template relative to the east reference plate, we have to multiply this angle by the distance between assembling holes and the center of the tower (about 2 m). Since there are four template parts (some of them contributing with a smaller lever arm, but we conservatively ignore this), the overall expected mechanical accuracy between the north and south reference plates is  $0.05 \text{ mrad} \times 2 \text{ m} \times \sqrt{4} = 0.2 \text{ mm}$ .

This number is close to the value coming from temperature variation. For instance, for a 5 degrees centigrade difference (that is the expected maximum difference between the workshop where the plates were machined and the NE building), over 2.8 m (the distance separating the two inner reference pins of the north and south reference plates) and the thermal expansion coefficient for aluminum ( $23 \mu\text{m}/\text{m}/\text{K}$ ) we get 0.3 mm.

Adding linearly (to be conservative) the two numbers, the expected mechanical uncertainty on the 2.8 m distance of the two inner reference pins is about 0.5 mm.

In the case of the north and east reference plates that are less than 2 meters apart and positioned with only two reference template parts, the systematic uncertainty is estimated to 0.3 mm. For the south to east reference plates, since the distance is similar to the south to north reference plates, we will use 0.5 mm as systematic uncertainty.

### 3 Precision of the measuring tapes used

To measure the distance, we use category 1 measuring tapes that are expected to have an accuracy of  $\pm 0.4 \text{ mm}$  at 3m ( $\pm 0.3 \text{ mm}$  at 2 m and  $\pm 0.6 \text{ mm}$  at 5 m). The model used are Tajima H1630 MW (3m) for most of the cases and sometime 5m (Tajima H1550 MW).

The reference holes are equipped with pin having a central slot to host the measuring tape. The reading is made by inserting the measuring tape inside one pin with an offset of 10 cm (see left image of figure 3) and then reading the distance on the other pin after subtracting the 10 cm offset (right image of figure 3). The reading is rounded to 0.5 mm. The reading error is therefore  $0.5/\sqrt{12} = 0.15 \text{ mm}$  and fluctuate from one measurement to another.

If the ruler is not perfectly straight, and have a deflection of 5 cm (maximum value during our measurements), the bias over 2.8 m is  $2.8(1/2)(0.05/2.8)^2 = 0.44 \text{ mm}$ .

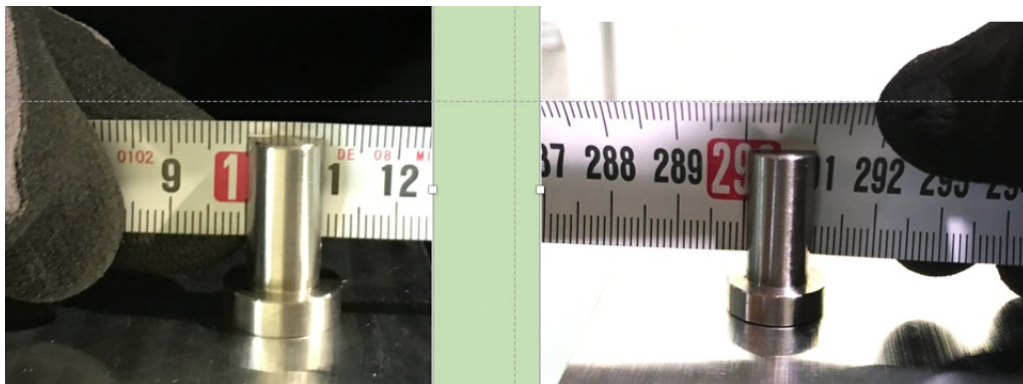

Figure 3: Example of distance reading. In this case, the distance between the two pins is  $2900.5 - 100.0 = 2800.5 \text{ mm}$  )

### 4 Template testing at IPHC - 23 august 2021

Before assembling the supports for the NCal at VIRGO, the system was assembled at IPHC for preliminary measurements as shown in figure 4.



Figure 4: Top view of the complete assembly done at IPHC. In red is shown the aluminum template made of four plates used for the positioning, in blue are shown the aluminum reference plates and in green are the aluminum supports for the NCal.

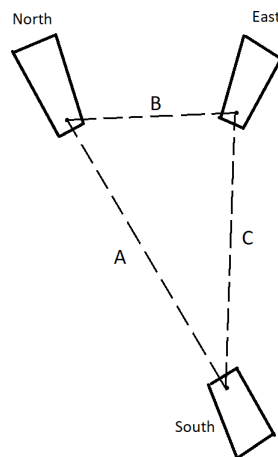

Figure 5: Outline of the supports after positioning. The distances between the supports are shown in black dotted lines labelled A, B and C.

Three distances needed to be measured, as shown on figure 5. Measurements are displayed on table 1. The 5m measuring tape was used. The "Expected" values are the distances from the CAD design.

	Distance A (mm)	distance B (mm)	distance C (mm)
Measured	2800.5	1812.0	2318.0
Expected	2800 (1200+1600)	1812.5	2318.6

Table 1: Measurements made at IPHC.

## 5 On-site Assembly at VIRGO NE - October 5, 2021

### 5.1 Preliminary measurements

The system was completely assembled in the NE building, next to the tower, to check the distances between the reference plates just before the final assembly around the tower (for some pictures, see the logbook the logbook entry [53390](#)). Three sets of measurements were done using the 3 m and 5 m measuring tapes. Between each set, the template was disassembled and then assembled again.

#### 5.1.1 First set of measurements

Measuring tape used	distance A (mm)	distance B (mm)	distance C (mm)
3 m	2800.0	1813.0	2319.0
5 m	2800.5	1813.0	∅

Table 2: First set of measurements made at Virgo, besides the tower.

#### 5.1.2 Second set of measurements

As explained, the template was removed then reassembled before making a second set of measurements shown in table [3](#).

Measuring tape used	distance A (mm)	distance B (mm)	distance C (mm)
3 m	2800.0	1812.5	2318.5
5 m	2800.5	∅	∅

Table 3: Second set of measurements made at Virgo, besides the tower.

#### 5.1.3 Third set of measurements

For the last set of measurements shown in table [4](#), the stacking order of the four plates composing the template was changed to see if there were some effect.

Measuring tape used	distance A (mm)	distance B (mm)	distance C (mm)
3 m	2800.0-2800.5	1812.5	2318.0
5 m	∅	∅	∅

Table 4: Third set of measurements made at Virgo, besides the tower.

## 5.2 Overall results and uncertainties

The averaged values of the measured distances are reported in table [5](#). These values agree very well with the expected values, well within the mechanical systematic uncertainties. Therefore when deriving NCal

systematic uncertainties, we will use the mechanical systematic uncertainties (last line of table 5) for the uncertainties on the reference plates positions.

	distance A (mm)	distance B (mm)	distance C (mm)
Average values	$2800.3 \pm 0.3$	$1812.6 \pm 0.4$	$2318.4 \pm 0.5$
Expected values	$2800.0 \pm 0.5$	$1812.5 \pm 0.3$	$2318.6 \pm 0.5$

Table 5: Average distances compared to the expected ones. The quoted uncertainties on the averaged values are just the RMS of the measurements, without the systematic error of the category 1 ruler (0.3 mm). The quoted expected error have been discussed in the template design section.

Side remark: When positioning the references plates on top of their supporting frames, the foreseen 5 mm clearance of the assembling holes was not enough. Some holes on the supporting frames have been drilled again (for the north and east supports) with an offset approaching 1 cm in some cases. This just confirms that the tower base is not an accurate reference frame. Therefore, the overall position of the NCal reference plates relative to the mirror is unknown by several millimeters.

### 5.3 Additional measurements: supporting beams vs reference plates

After the installation of the reference plates, the positions of the upper metal beams which will hold the NCal were measured, relative to the reference plates. A plumb line and a measuring tape were used. The results are in table 6.

Support	near position: lateral offset	far position: lateral offset	beam to ref. plate distance
North	10 mm toward the rib	2 mm away from the rib	1066 mm
East	15 mm toward the rib	1 mm toward the rib	1059 mm
South	5 mm toward the rib	6 mm toward the rib	1067 mm

Table 6: Supporting beams position relative to the reference plates. The lateral offsets are measured at the position of the M6 holes for the near or far safety rings. The uncertainty on the lateral offsets could be a few millimeter since a simple plumb line was used.

VIRGO emplacement plaques (bleus) et gabarits

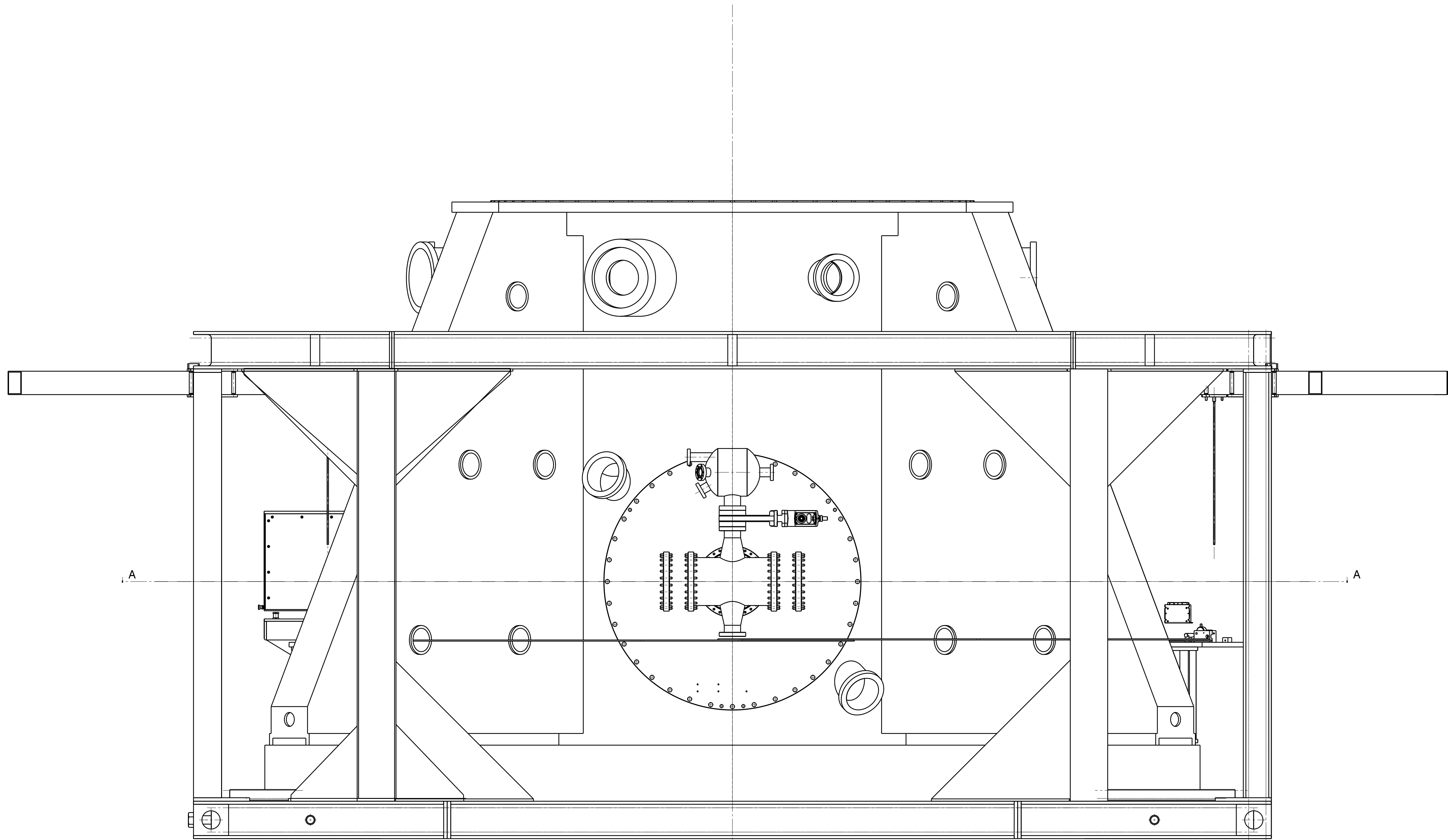

Vue de face  
Echelle : 1:10

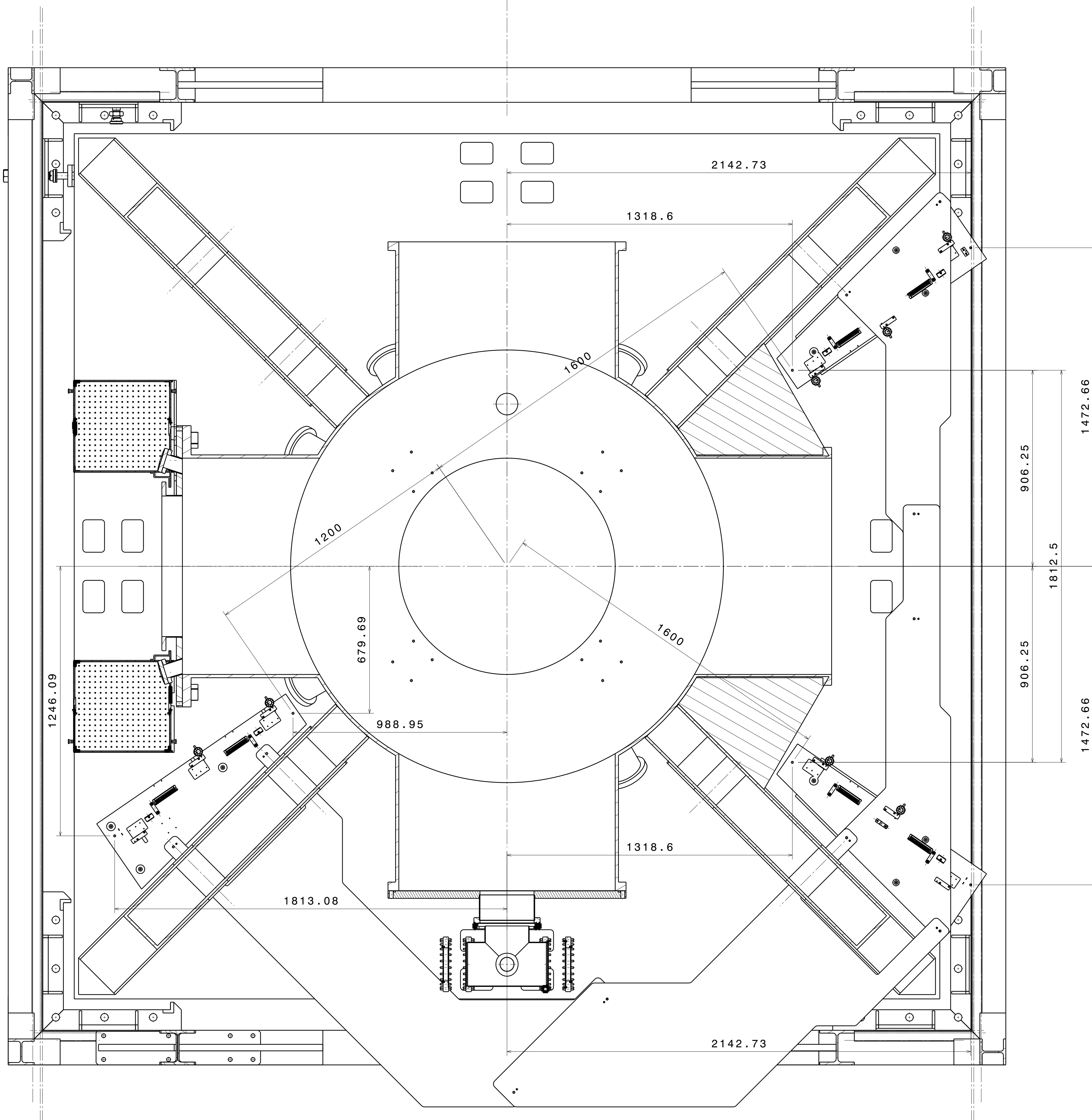

Coupe A-A  
Echelle : 1:10



VIRGO  
 Plan pour l'emplacement des trous du châssis

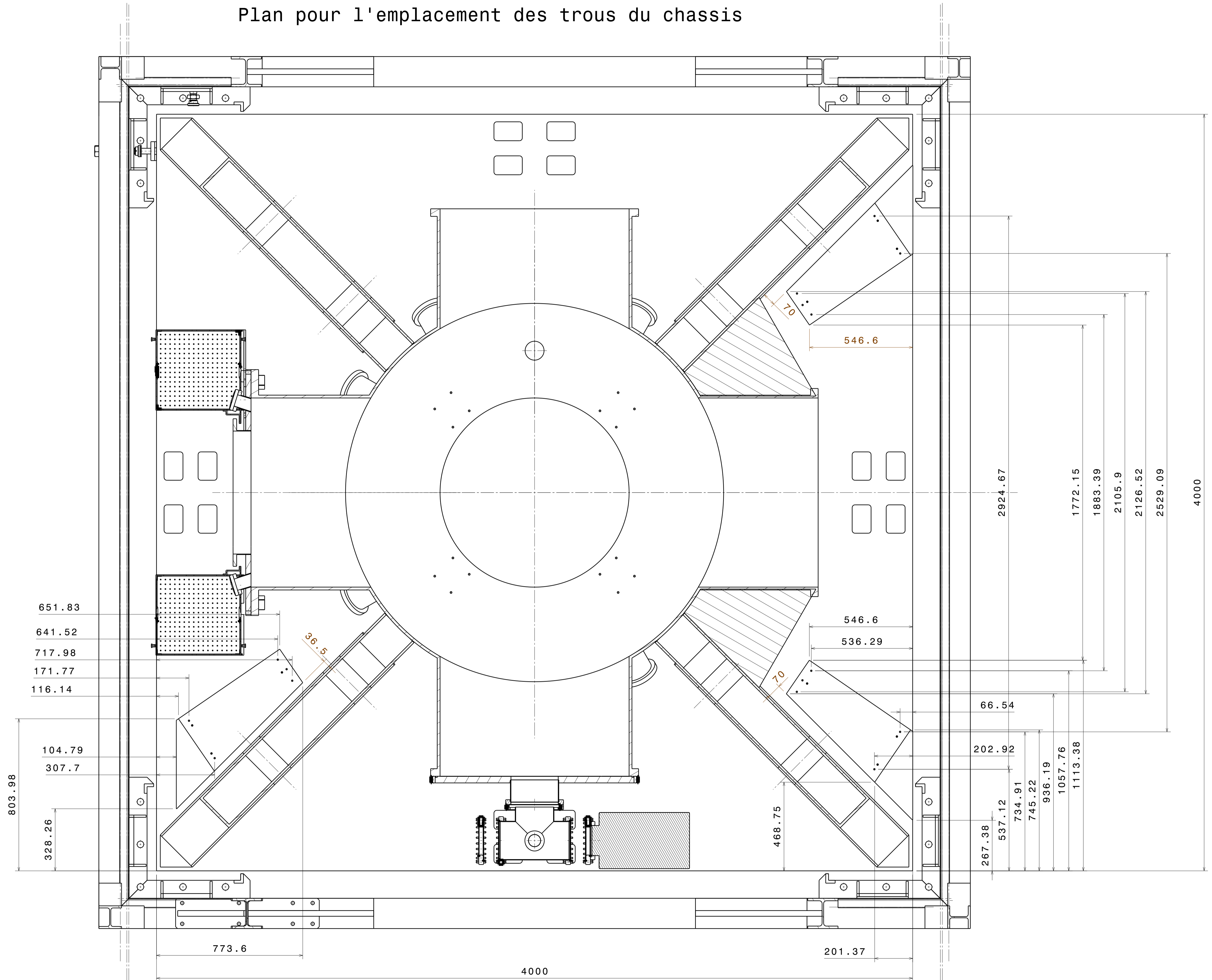

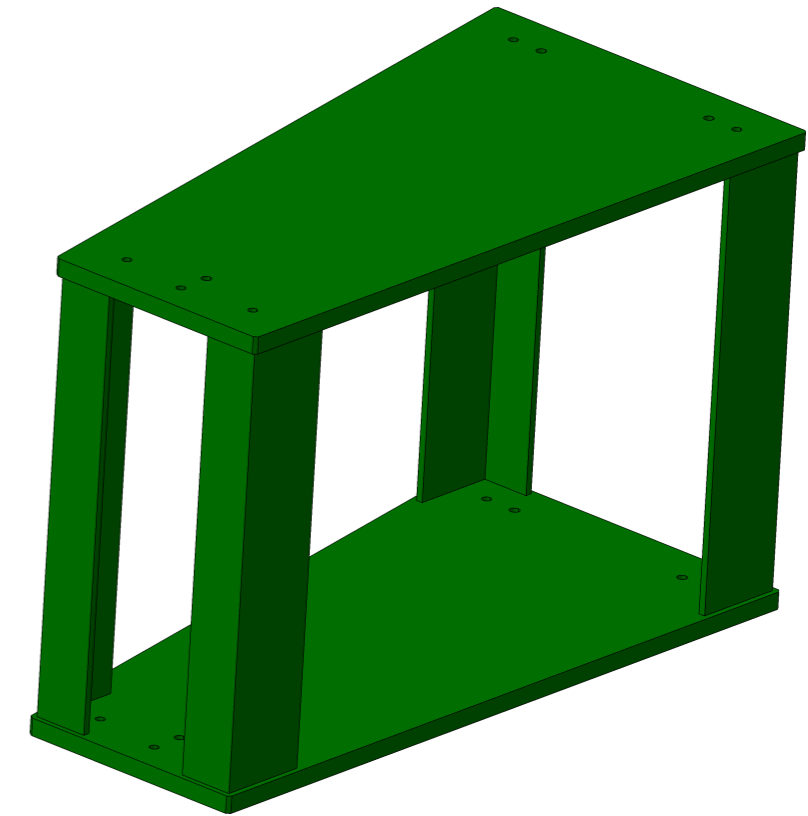
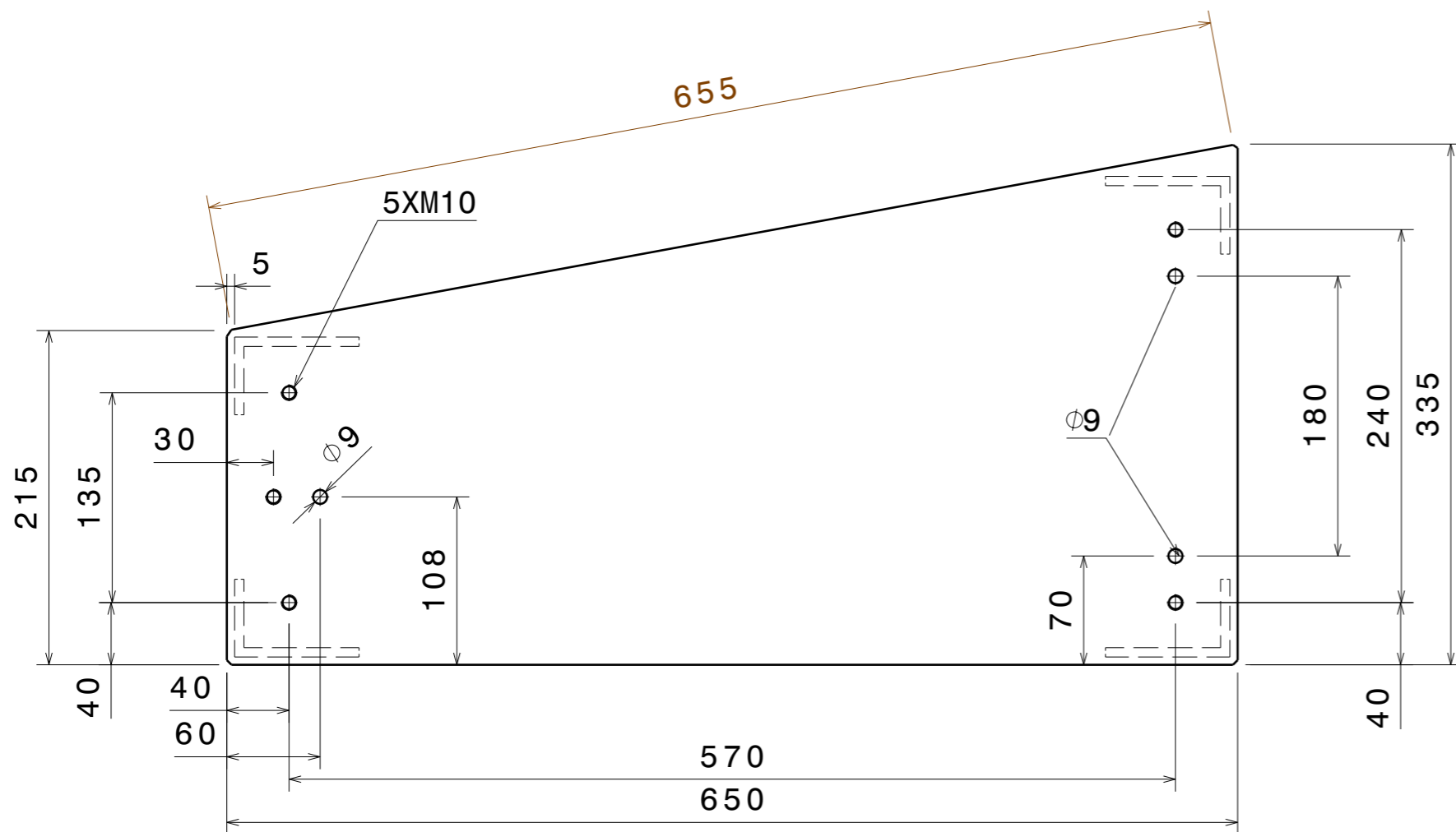

Vue isométrique  
Echelle : 1:6

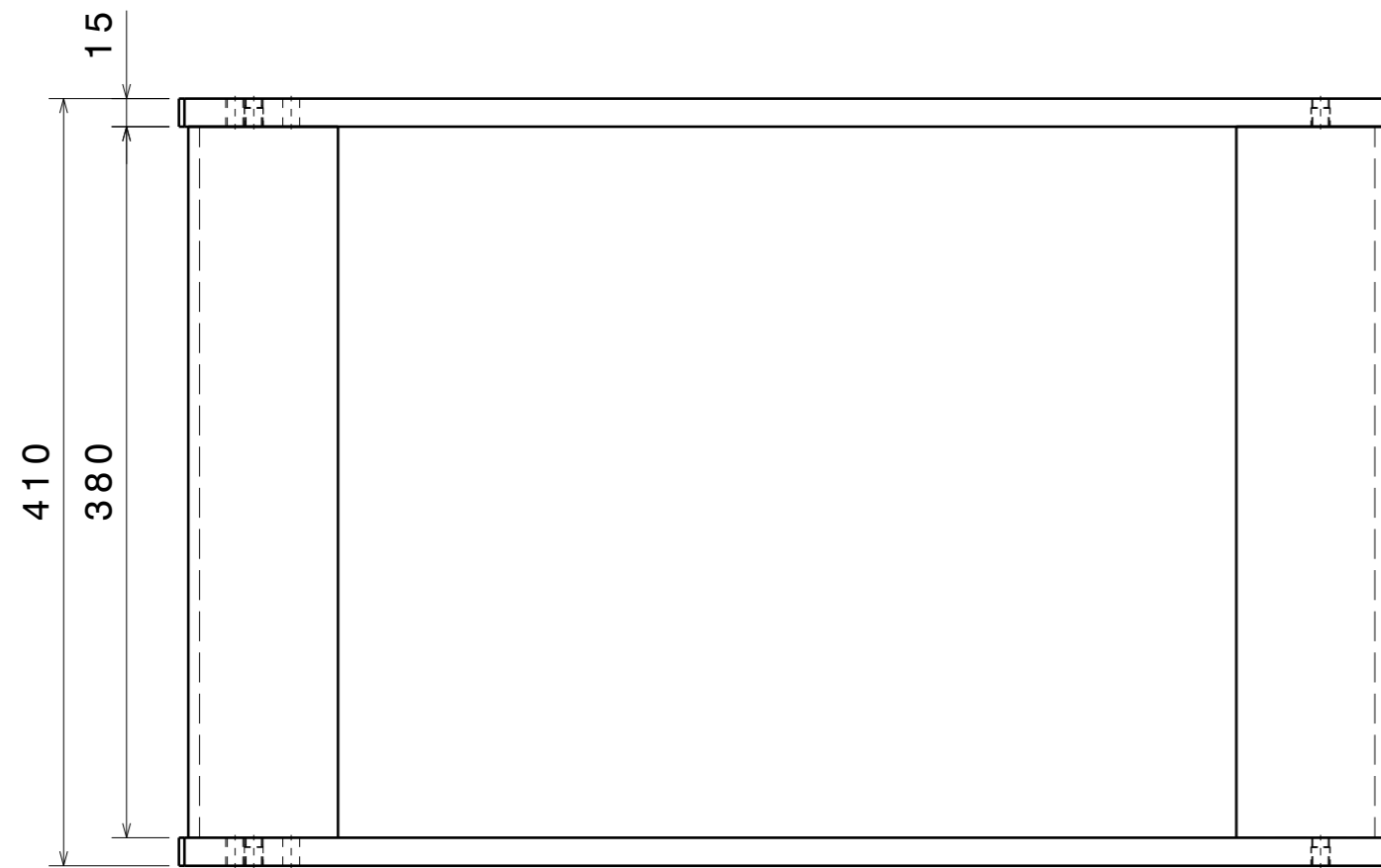

Chassis composé de:

- 2 Plaque identiques en tole alliage Al (AW-5754) ép 15mm
- 4 Pieds corniere en alliage Al (AW-6060) 50X80X6 mm soudés

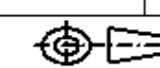
N°	4	Aliage Alu	Traitement de surface	18 Kg	Dessin d'ensemble
Rug. gén. : Ra = 1,6	Qté	Matière	Chanfreins:3 à 45°	Masse	Projet : VIRGO
		Chassis Ncal			
Dessiné par : V. Zeter		Vérifié par :		A3	Numéro
27/04/2021					Echelle 1:4
					

Copyright IN2P3 - 2018

H

G

F

E

D

C

B

A

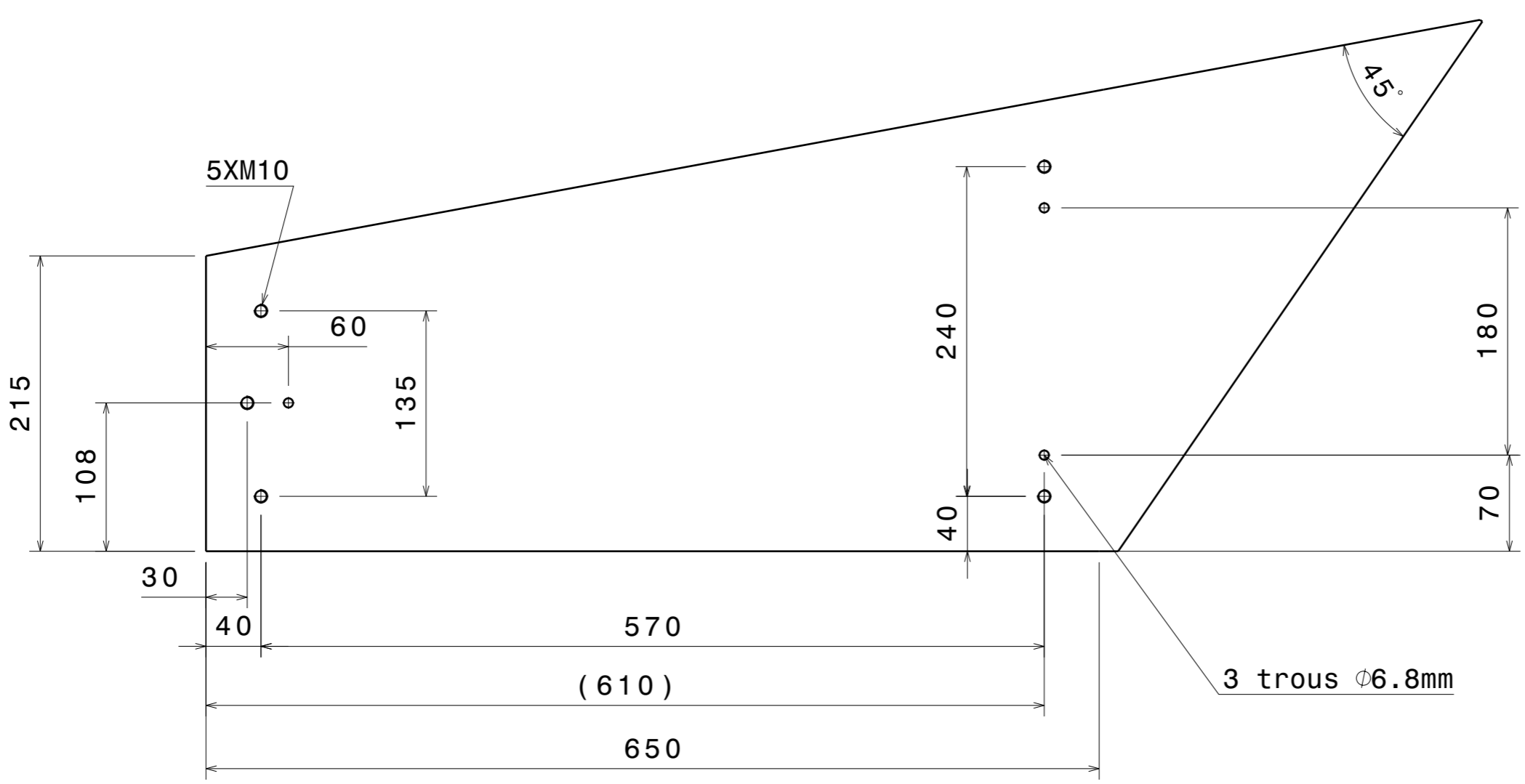

Vue de face  
Echelle : 1:4

Plaque gabarit trous pour chassis en tole acier ép 15mm

H

G

B

A

4

3

2

1

4

3

2

1

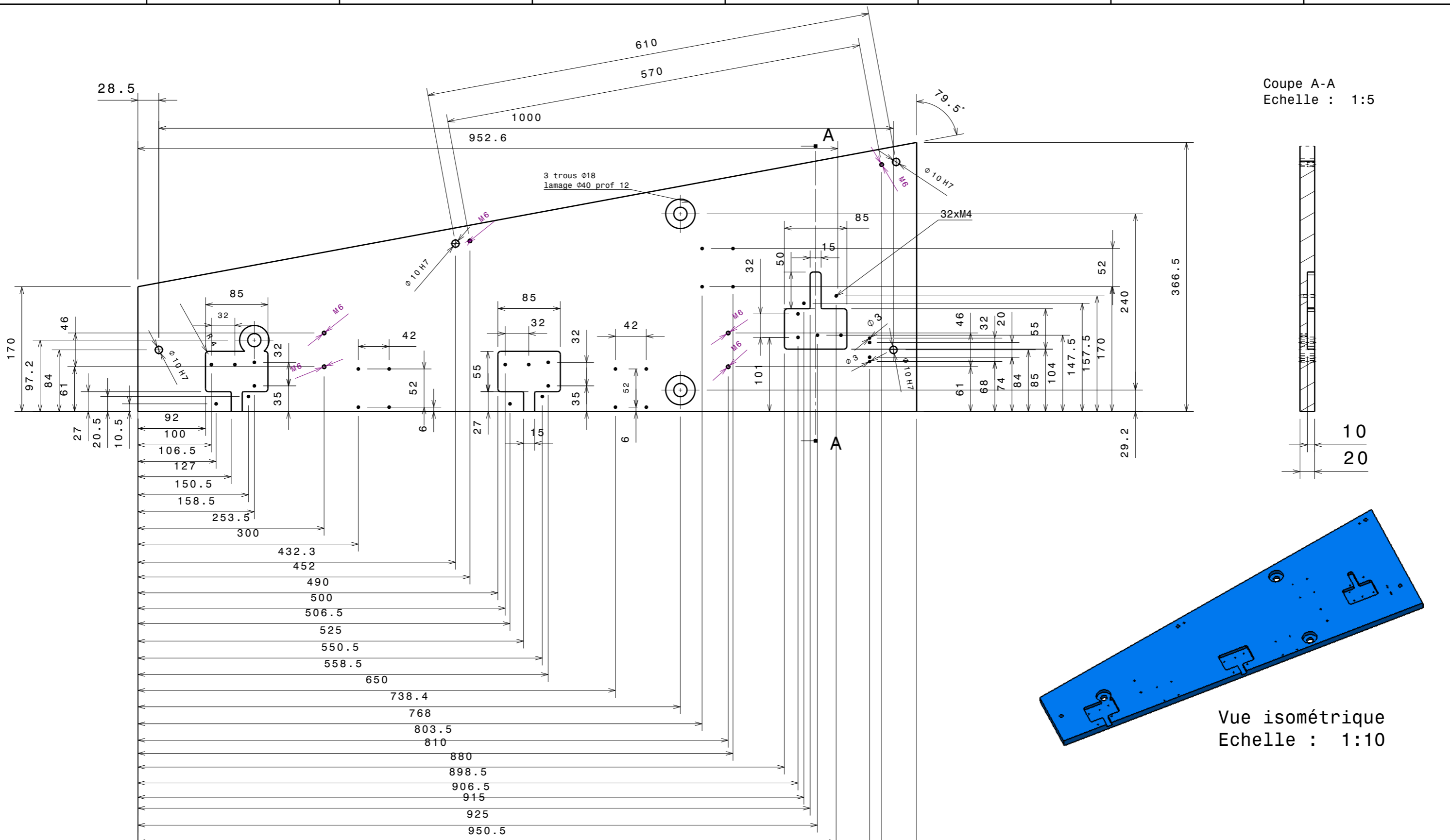

Coupe A-A  
Echelle : 1:5

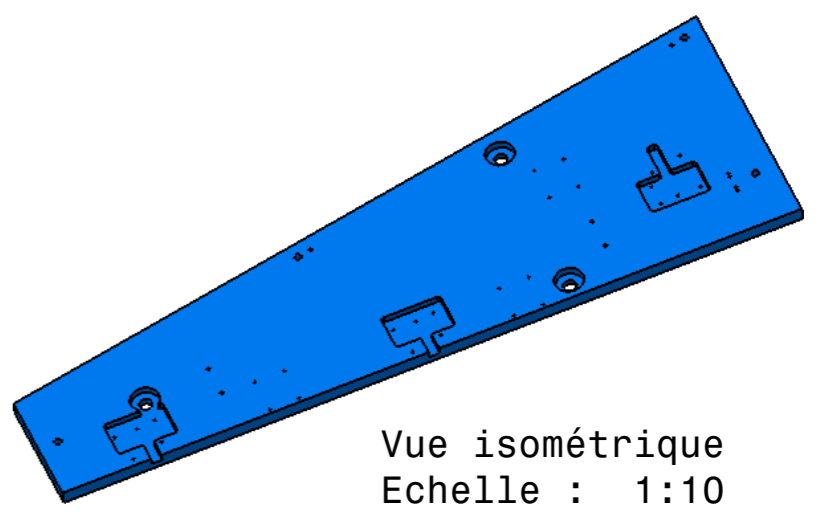
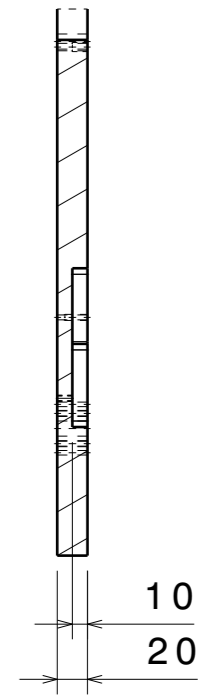

Vue isométrique  
Echelle : 1:10

- 28.5
- 97.2
- 84
- 61
- 46
- 27
- 20.5
- 10.5
- 92
- 100
- 106.5
- 127
- 150.5
- 158.5
- 253.5
- 300
- 432.3
- 452
- 490
- 500
- 506.5
- 525
- 550.5
- 558.5
- 650
- 738.4
- 768
- 803.5
- 810
- 880
- 898.5
- 906.5
- 915
- 925
- 950.5
- 996
- 1012.4
- 1060

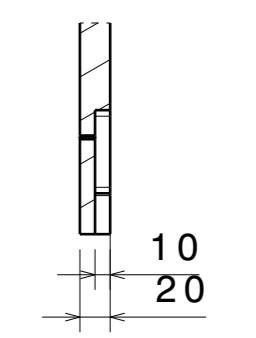
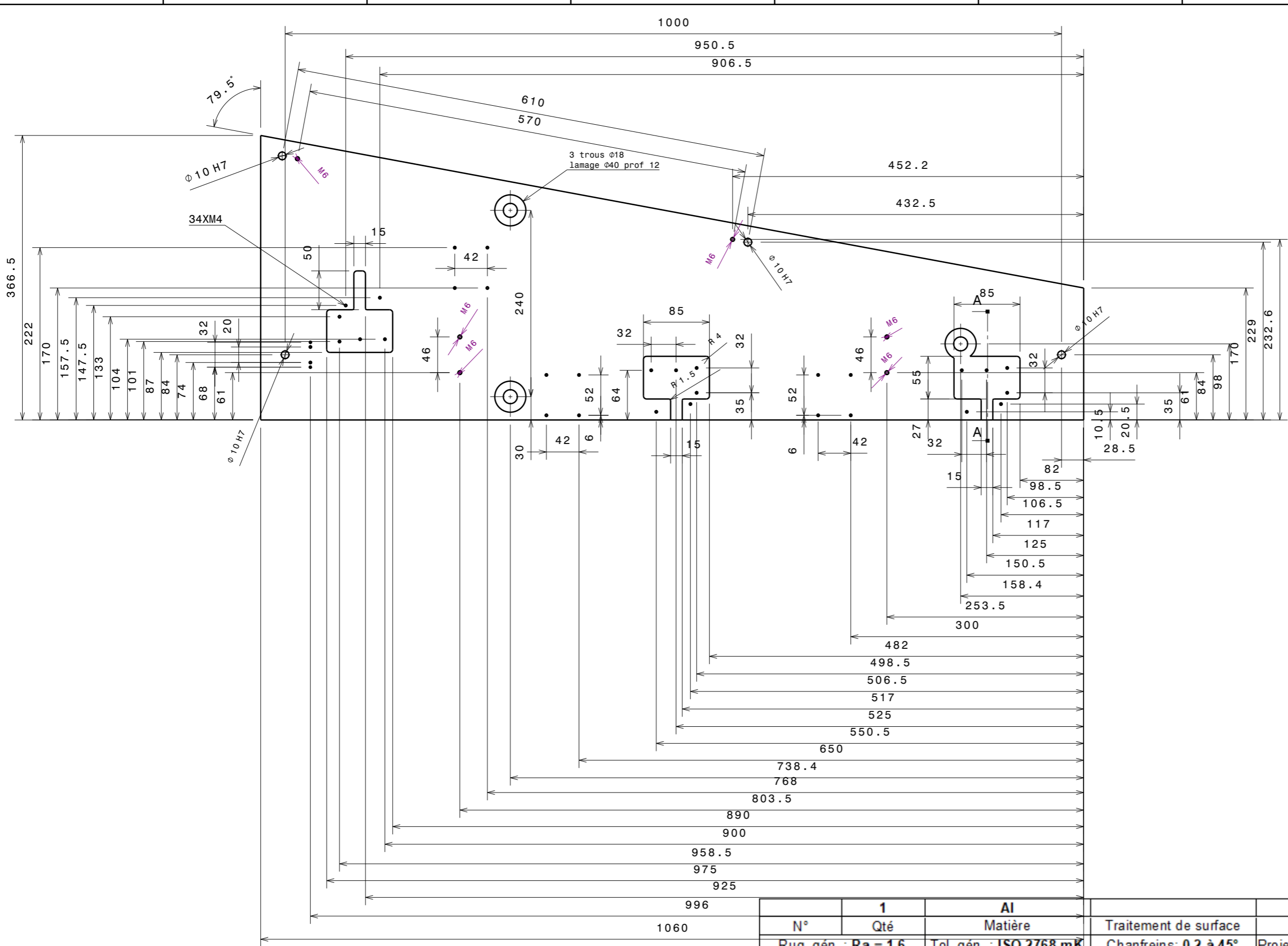

N°	Qté	Matière	Traitement de surface	Masse Kgs.	Dessin d'ensemble
	1	Al		15	
Rug. gén. : Ra = 1,6		Tol. gén. : ISO 2768 mK		Chanfreins: 0,2 à 45°	
CNRS - IN2P3			PLAQUE NORD (support Ncal)		
ULP <b>IPHC</b> Institut Pluridisciplinaire Hubert CURIE STRASBOURG 23, rue du Loess - BP 28 67037 Strasbourg Cedex 02		Dessiné par : V. Zeter 05/07/2021	Vérifié par :	A3	Numéro
				Echelle 1:5	

Copyright IN2P3 / IReS



Coupe A-A  
Echelle : 1:5

Vue de face  
Echelle : 1:5

1060	996	925	975	958.5	900	890	803.5	768	738.4	650	550.5	525	517	506.5	498.5	482	300	253.5	158.4	150.5	125	117	106.5	98.5	82	55	32	27	15	10.5	28.5	20.5	35	61	84	98	170	229	232.6
N°	1	AI	15	Traitement de surface		Masse Kgs.		Dessin d'ensemble																															
Rug. gén. : Ra = 1,6	Tol. gén. : ISO 2768 mK	Chanfreins: 0,2 à 45°	Projet :	VIRGO																																			
CNRS - IN2P3		PLAQUE_EST (Support_Ncal)																																					
 Institut Pluridisciplinaire Hubert CURIE STRASBOURG 23, rue du Loess - BP 28 67037 Strasbourg Cedex 02		Dessiné par :	Vérifié par :	A3	Numéro	Echelle 1:5																																	
		V. Zeter																																					
		06/07/2021																																					

Copyright IN2P3 / IReS

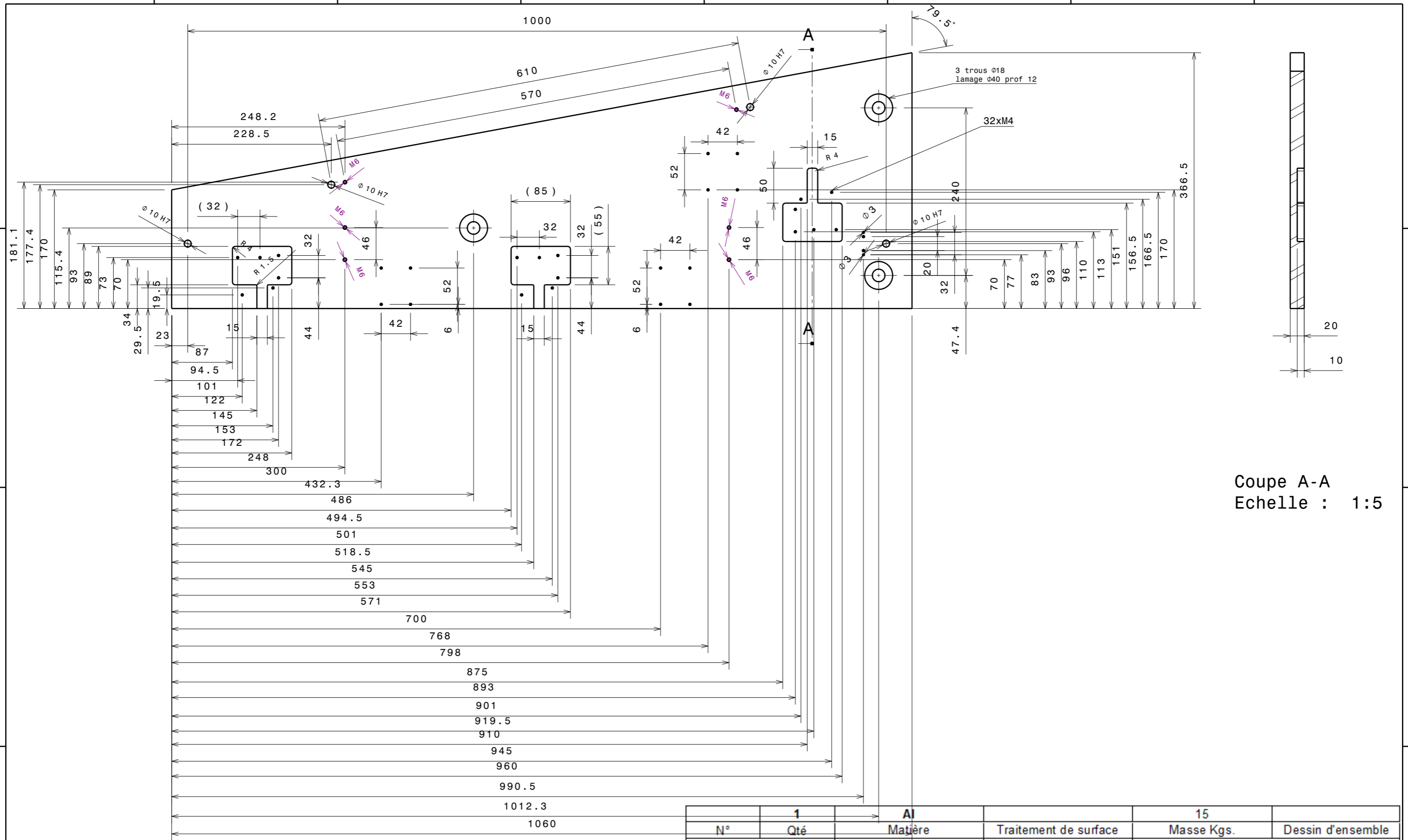

Vue de face  
Echelle : 1:5

Coupe A-A  
Echelle : 1:5

1		Al	15		
N°	Qté	Matière	Traitement de surface	Masse Kgs.	Dessin d'ensemble
Rug. gén. : Ra = 1,6		Tol. gén. : ISO 2768 mK	Chanfreins: 0,2 à 45°	Projet :	VIRGO
CNRS - IN2P3		PLAQUE SUD ( support Ncal)			
		Dessiné par :	Vérifié par :	A3	Numéro
		V. Zeter			Echelle 1:5
		06/07/2021			

Copyright IN2P3 - 1986

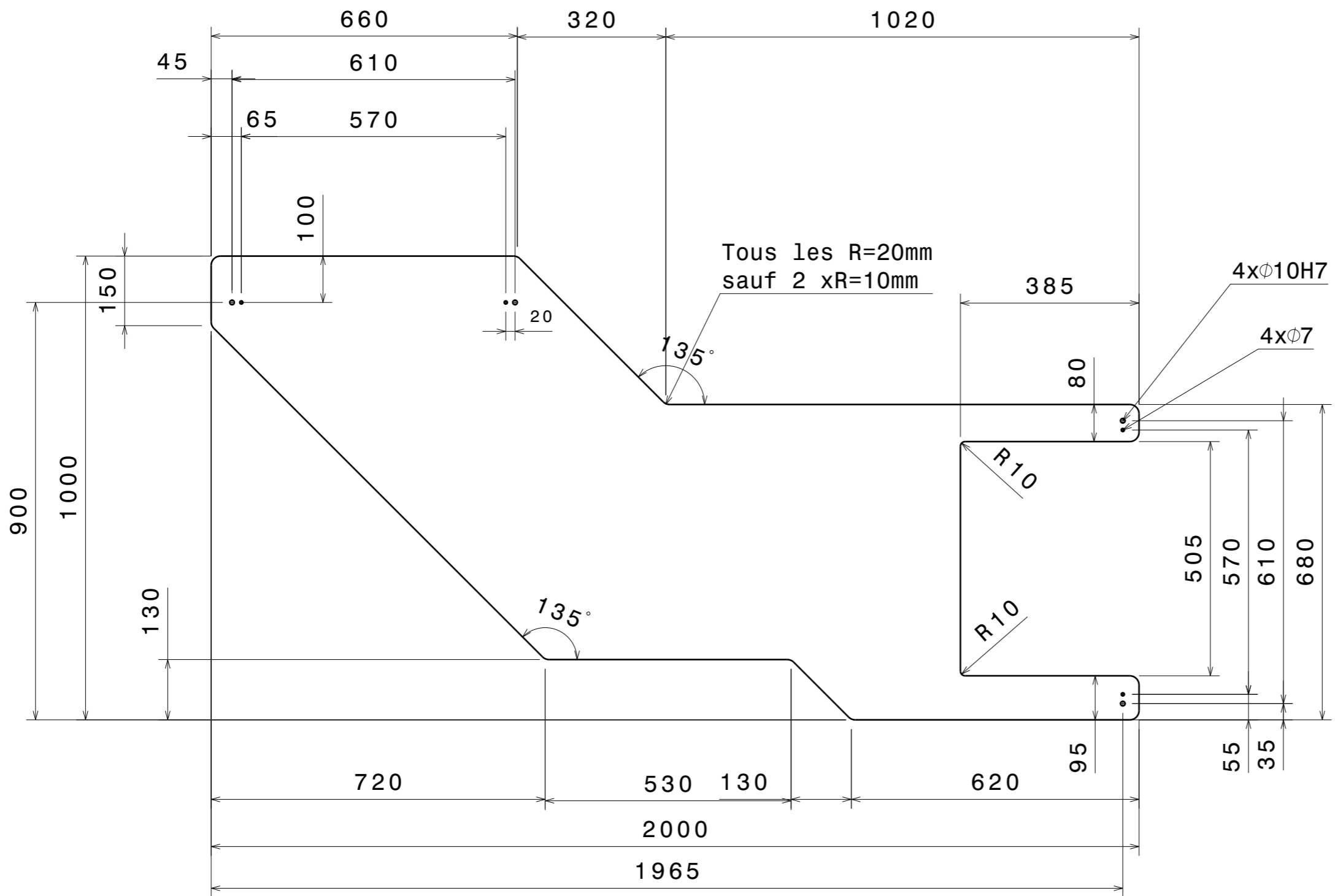

Vue de face  
Echelle : 1:10

Vue de gauche  
Echelle : 1:10

N°	Qté	Matière	Traitement de surface	Masse Kgs.	Dessin d'ensemble
Rug. gén. : Ra = 1,6		Tol. gén. : ISO 2768 mK	Chanfreins: 0,2 à 45°	Projet : VIRGO	
		GABARIT_EST			
 Institut Pluridisciplinaire Hubert CURIE STRASBOURG 23, rue du Loess - BP 28 67037 Strasbourg Cedex 02		Dessiné par : V. Zeter 03/07/2021	Vérifié par :	A3	Numéro
				Echelle 1:10	

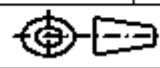

Copyright IN2P3/Line 3

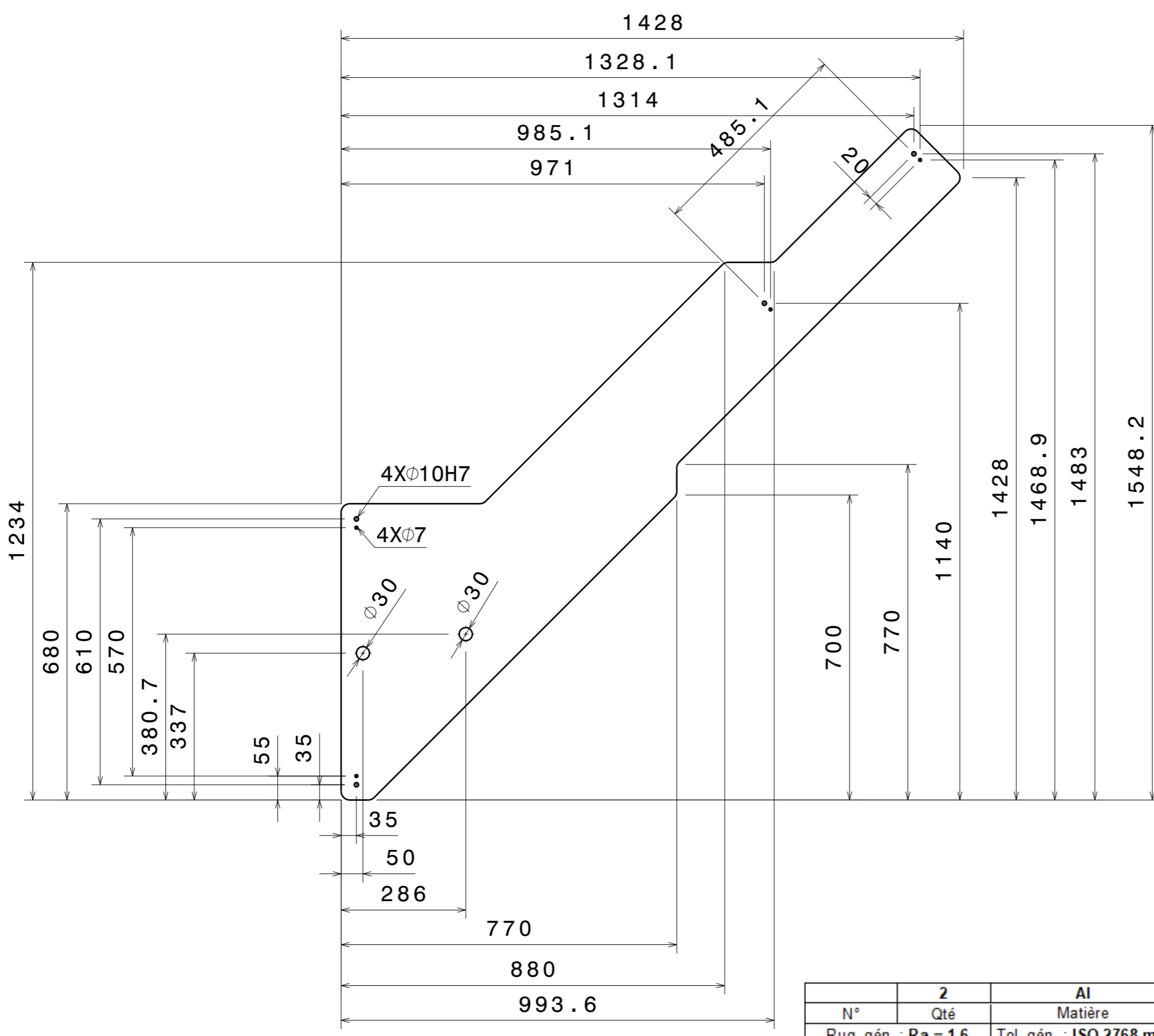

Al épaisseur 5mm

Vue de face  
Echelle : 1:10

N°	2	Al	Traitement de surface	12	Dessin d'ensemble
Rug. gén. : Ra = 1,6	Qté	Matière	Chanfreins: 0,2 à 45°	Masse Kgs.	Projet : VIRGO
 23, rue du Loess - BP 28 67037 Strasbourg Cedex 02		<b>GABARIT NORD</b>			
Dessiné par : V. Zeter		Vérifié par :		<b>A3</b>	Numéro
06/07/2021					Echelle 1:10

Copyright IN2P3 / IReS



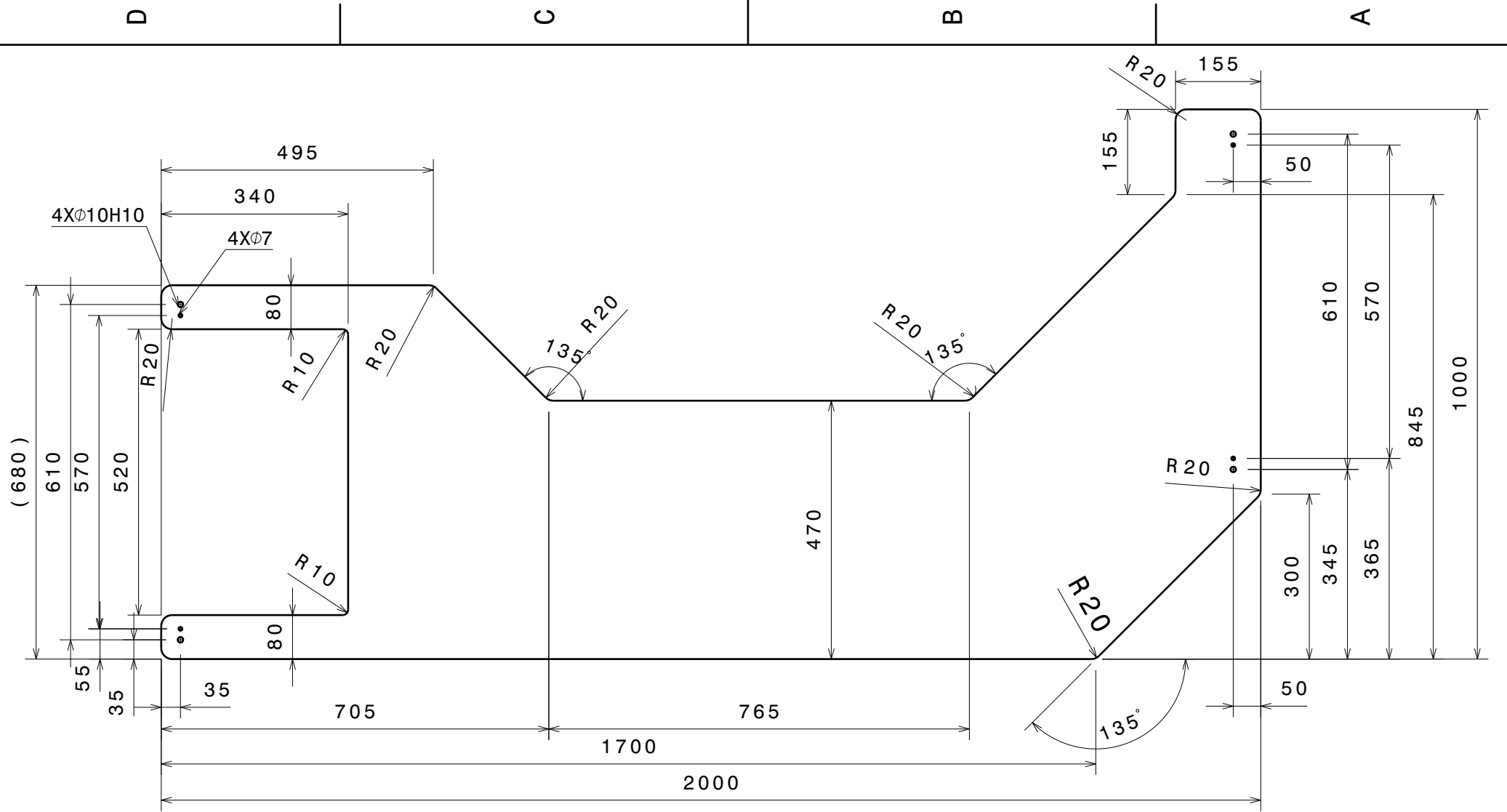

Plaque en Al ép. 5mm

	1	Al		13,5	
N°	Qté	Matière	Traitement de surface	Masse Kgs.	Dessin d'ensemble
Rug. gén. : Ra = 1,6		Tol. gén. : ISO 2768 mK	Chanfreins: 0,2 à 45°	Projet :	VIRGO
		<b>GABARIT SUD</b>			
Dessiné par : V. Zeter 03/07/2021		Vérifié par :		A4	Numéro
					Echelle 1:10

Copyright IN2P3 T H E S