

LIGO/Virgo physics and technology

Maddalena Mantovani

EGO - European Gravitational
Observatory

ISAPP Summer School on Gravitational Waves 2021

Global network of GW detectors



Second generation detectors

Global network of GW detectors



Global network of GW detectors: joint observational runs

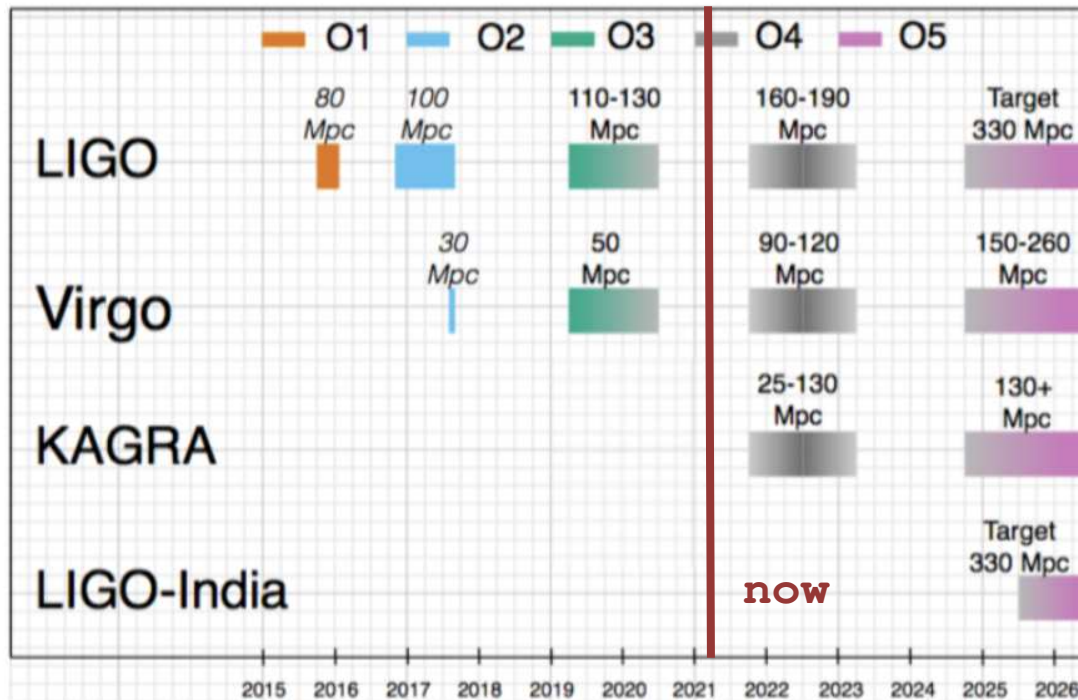

Abbott, B.P. et al. "Prospects for observing and localizing gravitational-wave transients with Advanced LIGO, Advanced Virgo and KAGRA". Living Rev Relativ 23, 3 (2020)

Global net-work of GW detectors: joint observational runs

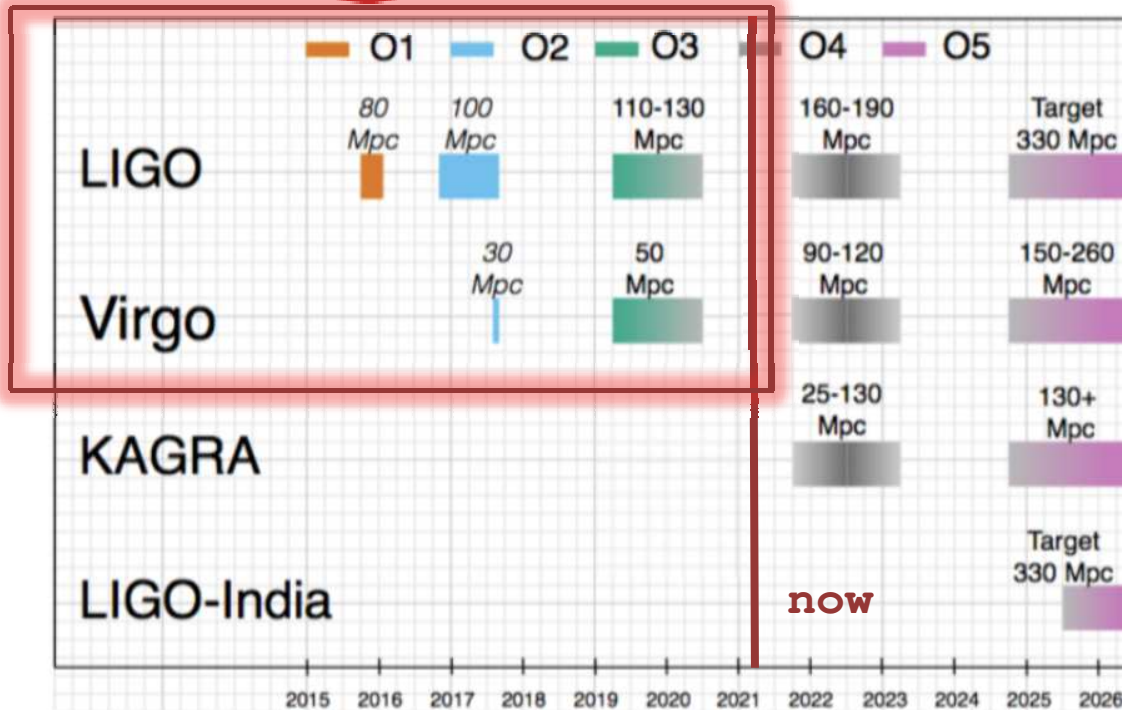

Abbott, B.P. et al. "Prospects for observing and localizing gravitational-wave transients with Advanced LIGO, Advanced Virgo and KAGRA". Living Rev Relativ 23, 3 (2020)

Global network of GW detectors: joint observational runs

The Nobel Prize in Physics 2017



© Nobel Media. III. N. Erna
Rainer Weiss
Prize share: 1/2



© Nobel Media. III. N. Erna
Barry C. Barish
Prize share: 1/4



© Nobel Media. III. N. Erna
Kip S. Thorne
Prize share: 1/4

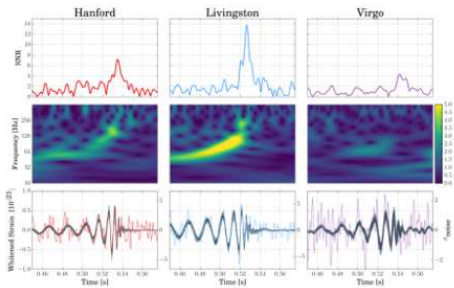

14 August 2017
First triple coincidence
LIGO/Virgo

COSMIC CLASHES

Gravitational-wave detectors have identified 50 collisions between black holes and other cosmic objects in the distant Universe. The US-based detector LIGO made the first discovery after a major upgrade in 2015; Italy-based Virgo joined the hunt in 2017.

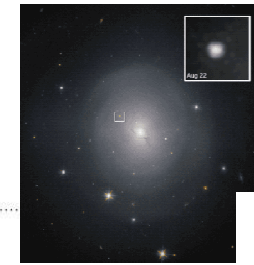
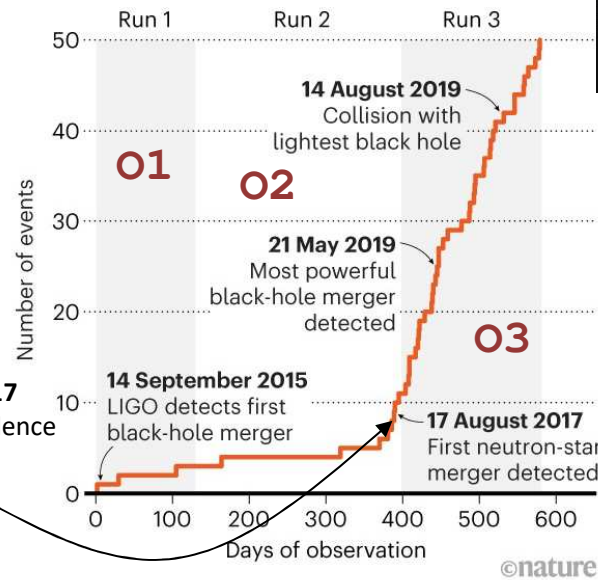

Electromagnetic
followup

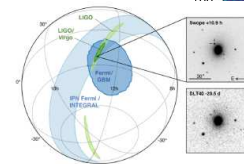
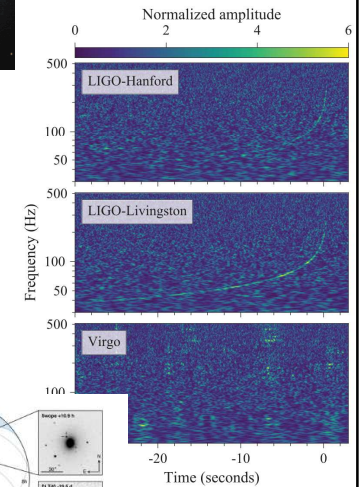

How these detectors work?

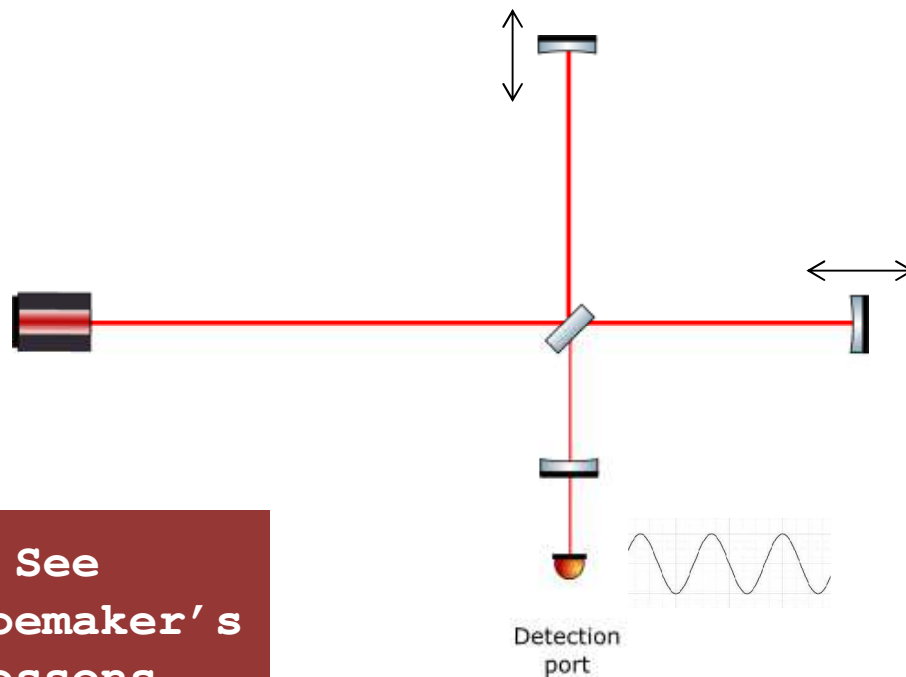

The detection principle is based on the Michelson working principle where the passage of a gravitational wave modify the interference condition at the detection port (dark fringe condition)

See
D. Shoemaker's
lessons

But, ... it is more complex

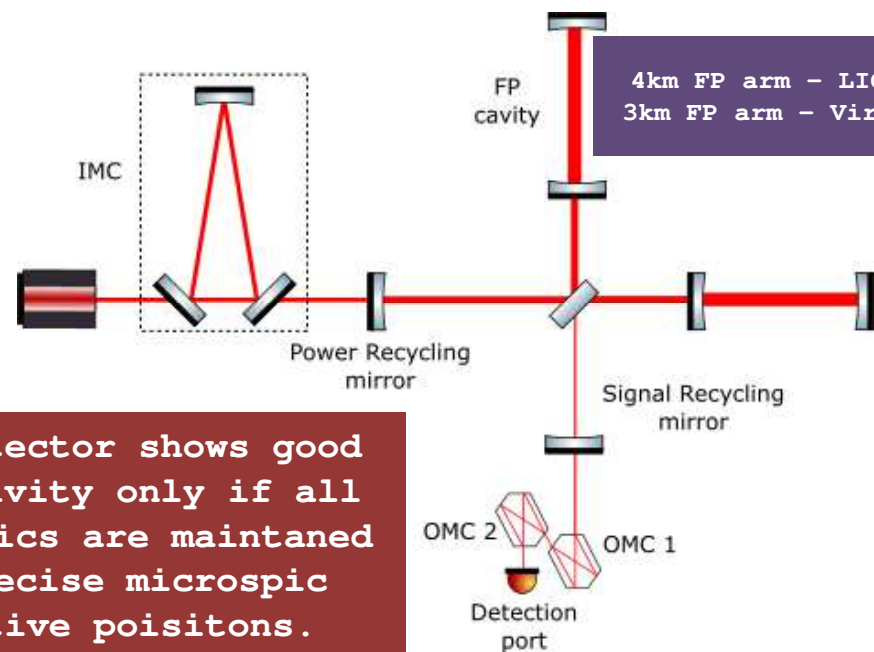

The detector shows good sensitivity only if all the optics are maintained at precise microscopic relative positions. Called Working point - see later

Additional cavities are added to the detector in order to:

- Input Mode cleaner - to stabilize and clean the input laser beam
- Fabry-Perot cavities - to increase the optical path length
- PR cavity - to increase the circulating power
- SR cavity - to enhance the dark fringe signal
- OMCs to clean the output beam

Vacuum



Virgo is the largest ultra-high vacuum in Europe, with a total volume of 6.800 m^3 .

The residual gas noise is due to the interaction of the laser beam with the particles which creates fluctuation of the optical path length. To mitigate the residual gas noise the detector is maintained in ultra-high vacuum (residual pressure 10^{-9} mbar).



LIGO is the largest worldwide ultra-high vacuum, with a total volume of 9000 m^3 .

Injection: generation of laser beam to the interferometer

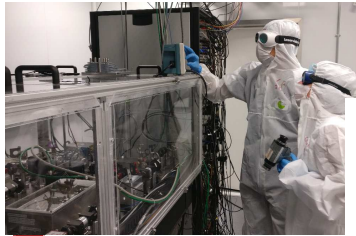

High power laser @1064nm
P=125 W

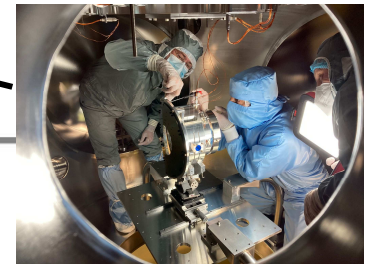
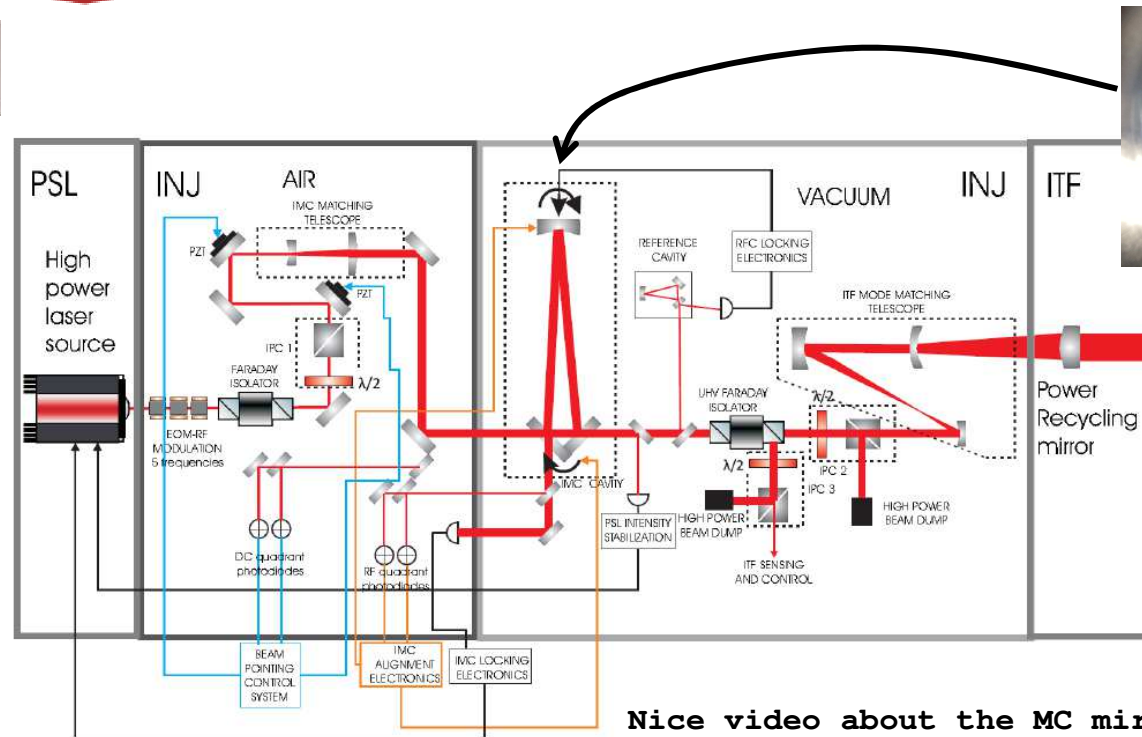

Installation of the Mode cleaner mirror

Nice video about the MC mirror installation

<https://youtu.be/kYu1MCJHx-A>

Detection

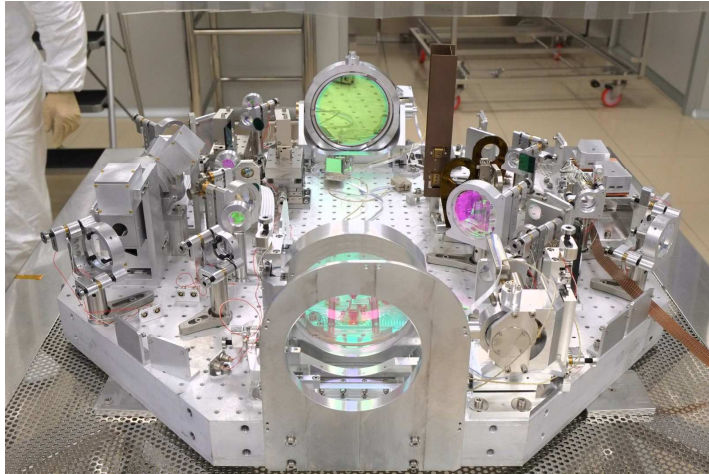

Detection bench



OMC

Mode Matching telescope:
to re-size the beam coming
from the Interferometer

Output Mode cleaner: to
clean the beam mode before
detection

**Dark fringe photo-
detector:** sensing detector
for destructive
interference fluctuation

Detection



All the sensors, not only the main gravitational wave sensor, are kept suspended under vacuum to reduce the environmental noise that can spoil the signals



Suspensions

LIGO

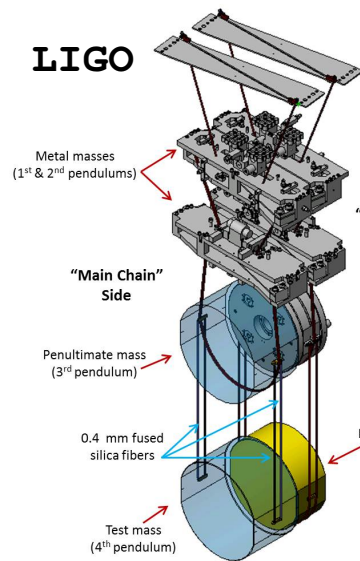

Isolation on all the 6 directions

"Reaction Chain" Side

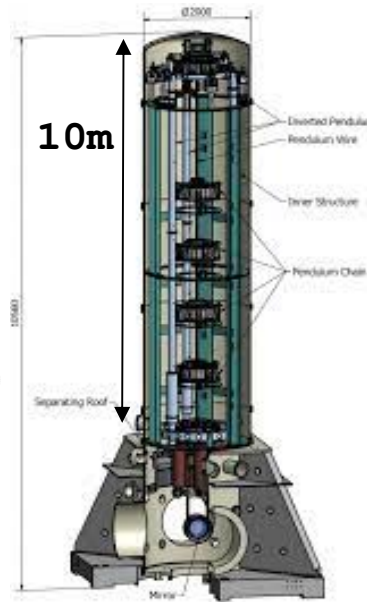
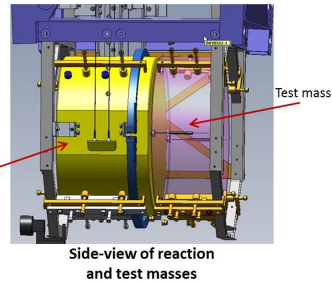

Virgo

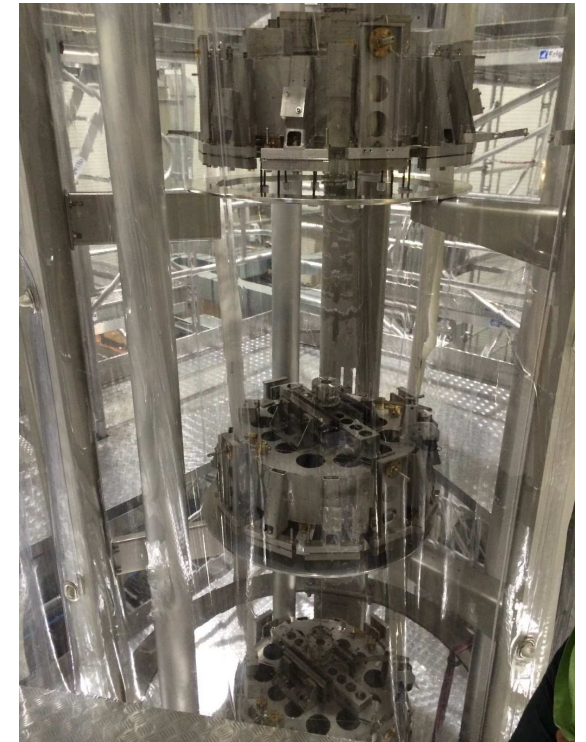

You can see more in the EGO/Virgo virtual visit on Friday

Detectors sensitivity

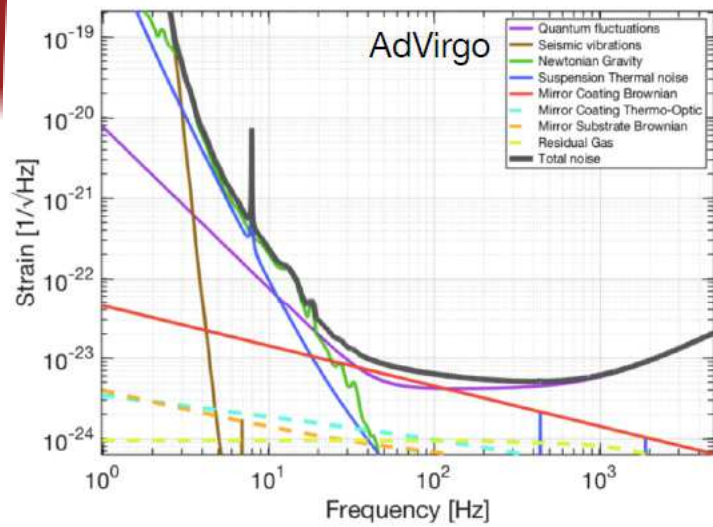

Only fundamental noises are shown

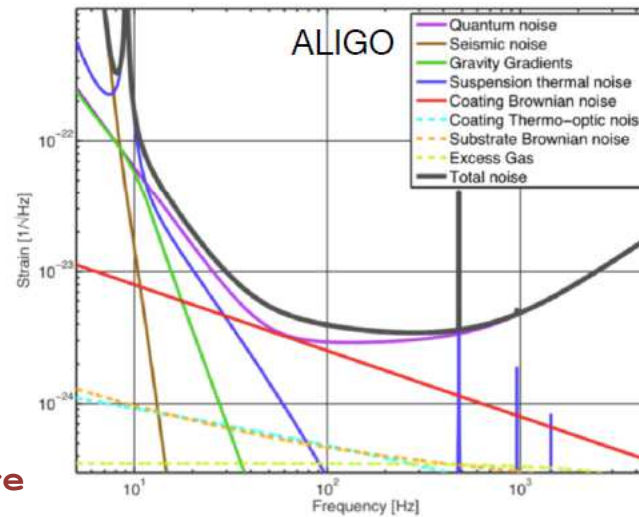

More in detail:

- Residual gas noise
- Seismic noise
- Newtonian noise
- Quantum noise
- Thermal noise

Technical noise sources

But not only the fundamental noises are important, the **Technical noises** play an important role.

The technical noises are mostly due to the fact that the position of the optics has to be actively controlled to keep the working point

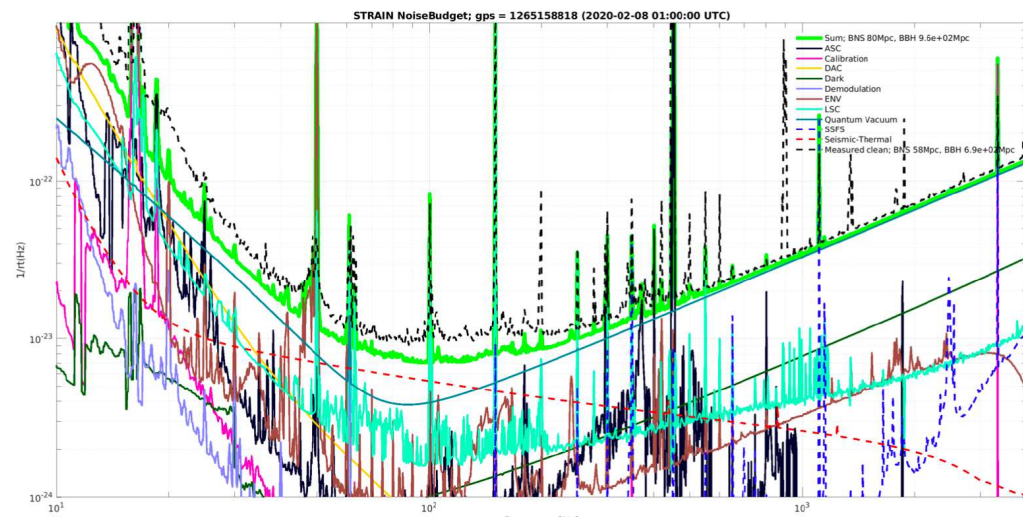

Virgo online noise budget

Global working point

The detector provide good sensitivity only if all the main compontens are positioned in a very precise relative microscopic position. These relative positions are the so called longitudinal dofs

Operational conditions:

- Arm cavities on resonance
- Recycling cavities on resonance
- Michelson on destructive interference

And

The mirrors aligned with respect to the beam (alignment working point)

$$DARM = \frac{L_N - L_W}{2}$$

$$CARM = \frac{L_N + L_W}{2}$$

$$MICH = l_{NI} - l_{WI}$$

$$PRCL = l_{PR} + \frac{l_{NI} + l_{WI}}{2}$$

$$SRCL = l_{SR} + \frac{l_{NI} + l_{WI}}{2}$$

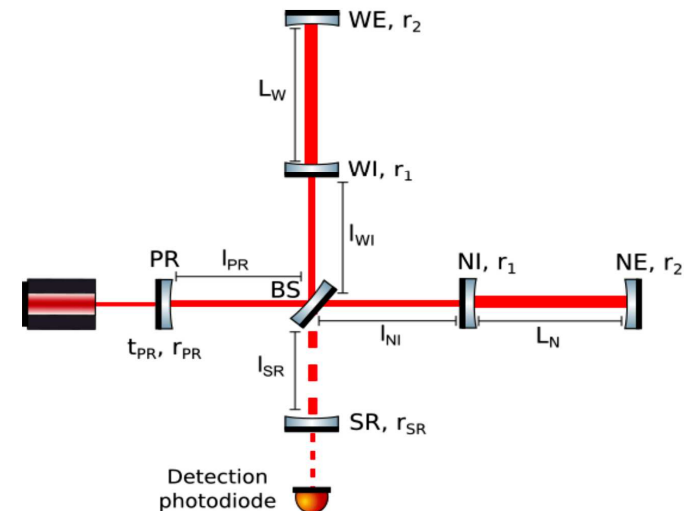

The working point has to be kept for long time to ensure high duty cycle for scientific data taking

What is a cavity and a cavity resonance?

Optical resonator: allows light to circulate in a closed path.
 When it is on resonance the optical path is a multiple of λ

Resonance: maximum power resonating inside the cavity

$$\delta\Phi \propto (\nu \cdot \delta L + L \cdot \delta\nu)$$

Finesse: it quantifies the quality factor of the cavity

$$P_{\text{rec}}/P_{\text{in}} \approx 2 \cdot F / \pi$$

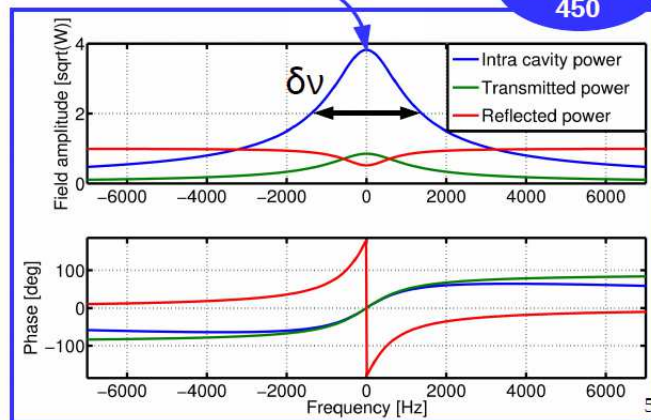
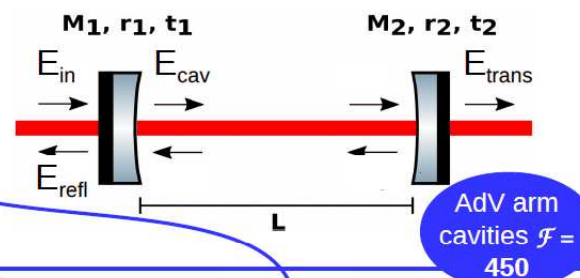

J. Casanueva

What is a stability of a cavity?

Only certain ranges of values for R_1 , R_2 , and L produce stable resonators in which periodic refocussing of the intracavity beam is produced(*) (STABLE CAVITY). If the cavity is unstable, the beam size will grow without limit, eventually growing larger than the size of the cavity mirrors and being lost.

$$g_i = 1 - L/R_i \quad 0 < g_1 g_2 < 1 \Rightarrow \text{stable cavity}$$

The stability of a cavity set also the capability of the cavity to "clean" the resonating beam from modes different from the fundamental mode.

The resonance position of the modes depends on the cavity parameters

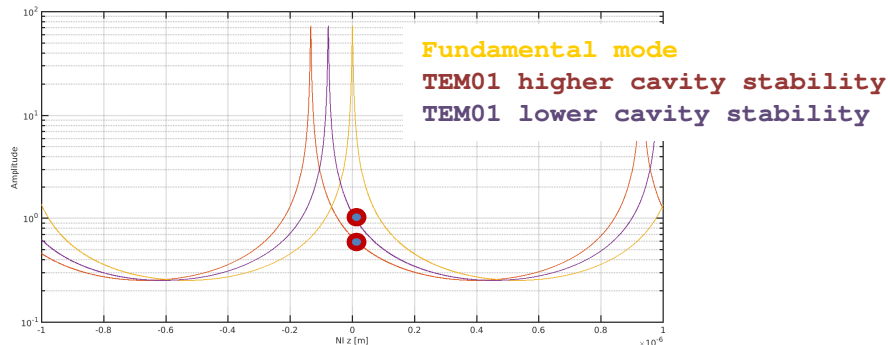

(*) cit wikipedia

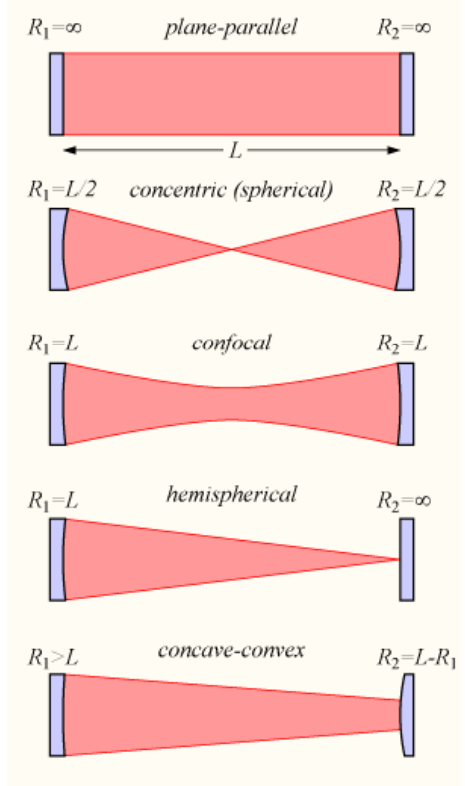

How to sense a cavity length deviation?

The beam is phase modulated creating sidebands around the carrier (ω_0) at \pm the modulation frequency, Ω .

The Error signal (PDH) \rightarrow beat note between carrier and non-resonant sidebands

The signal in reflected is demodulated to select the interesting term.

Two signals:

-in-phase (P)

-in-quadrature (Q)

Example of Pound-Drever-Hall (PDH) signal

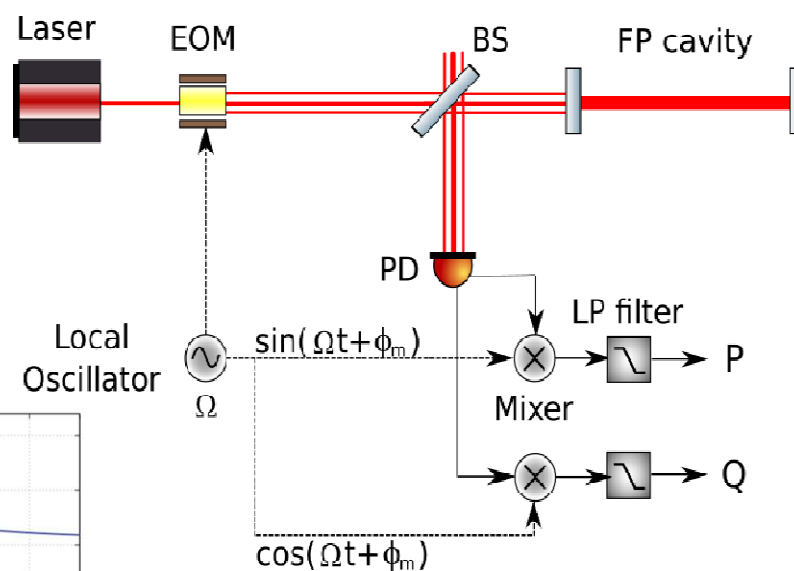
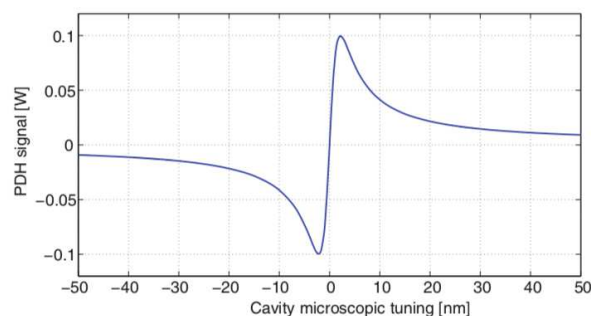

How to control a cavity length deviation?

The control is done implementing active feed-back which correct the length variation by acting on the mirror suspension.

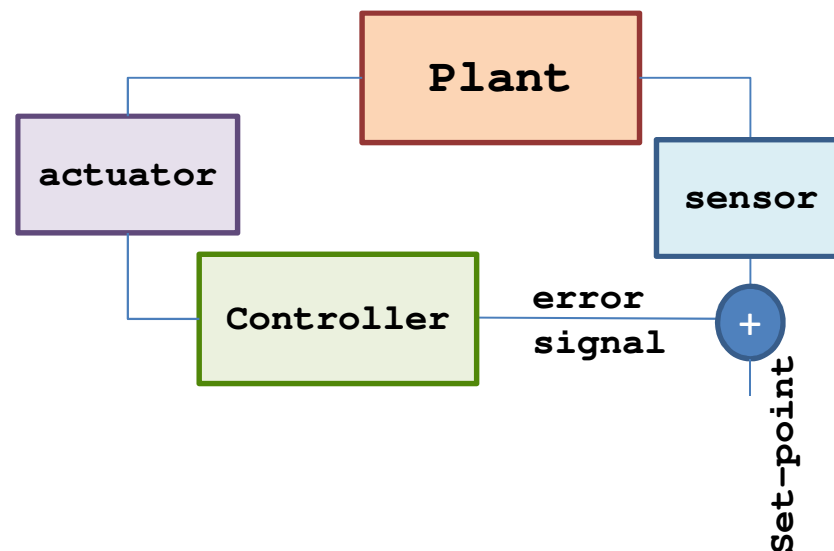

Lock acquisition LIGO & Virgo

The lock of the whole system is not easy like the lock of a single cavity (more dofs to be taken into account and coupled cavities). For this reason a procedure to bring the mirrors from un-controlled state to be controlled in the final working point has to be implemented. The so called lock acquisition.

Which is the trick?

The trick is to start from a simple un-controlled configuration and then pass to more and more complex configurations (adding dofs to be controlled).

(*) D. Martynov, 'Lock Acquisition and Sensitivity Analysis of Advanced LIGO Interferometers', PhD, California Institute of Technology, Pasadena (2015)

(*) K. Izumi, S. Dwyer, L. Barsotti, 'Simulation Study for aLIGO Lock Acquisition', LIGO note, LIGO-T1400298-v1

(*) J. Casanueva, N. Leroy "Auxiliary Laser system: study of the lock acquisition strategy" Virgo note, <https://tds.virgo-gw.eu/ql/?c=14154>

Lock acquisition LIGO & Virgo

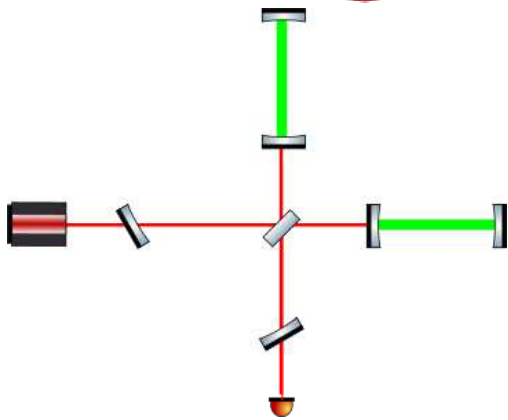

Misalign the PR & SR mirror in order to have only the CARM and DARM dofs.

Lock DARM & CARM using an auxiliary laser (green beam).

2 dofs: DARM & CARM

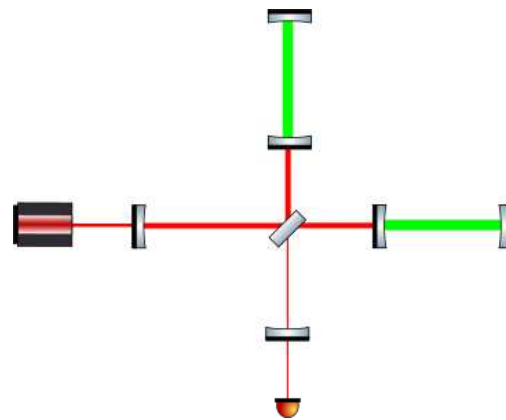

Move the resonance of the arms far from the IR resonance (Central ITF does not see anymore the arm cavities). Realign the recycling mirrors and lock the central area dofs:

3 dofs: MICH, PRCL and SRCL

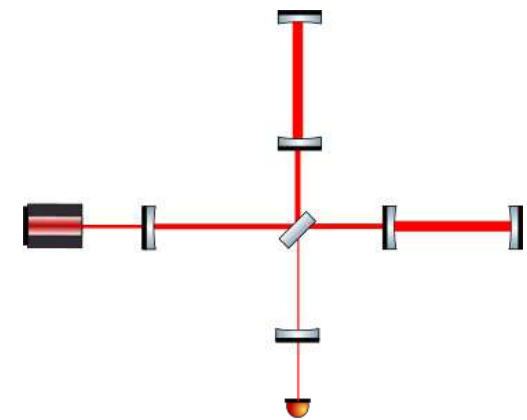

Bring back the resonance of the arms to the IR, having all the dofs controlled.

5 dofs: CARM, DARM, MICH, PRCL and SRCL

Lock acquisition LIGO & Virgo

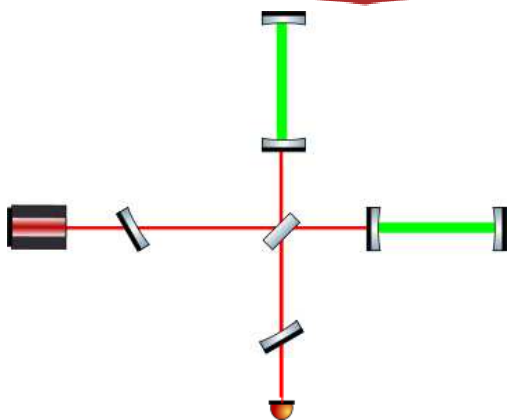

In this phase the opto-mechanical system is reduced to two single cavities.

The cavity is on resonance of a green laser (injected from the back side of the end mirrors). The length of the cavity is controlled with the mirror actuators at low frequency to match the resonance of the green beam (below 10Hz) while at high frequency the frequency of the green laser is tuned to match the length of the cavity

Misalign the PR & SR mirror in order to have only the CARM and DARM dofs.

Lock DARM & CARM using an auxiliary laser (green beam).

2 dofs: DARM & CARM



R. Bonnand

Lock acquisition LIGO & Virgo

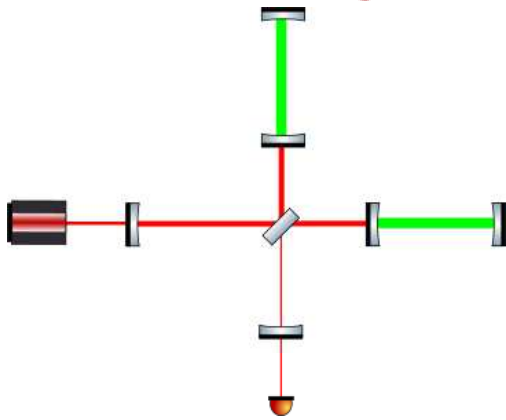

Move the resonance of the arms far from the IR resonance (Central ITF does not see anymore the arm cavities). Realign the recycling mirrors and lock the central area dofs:
3 dofs: MICH, PRCL and SRCL

The arms, thanks to the green lock, are driven away from the resonance of the Infra-Red (the main laser). Then the opto-mechanical system is reduced only to the central area.
PRCL MICH and SRCL are locked simultaneously.

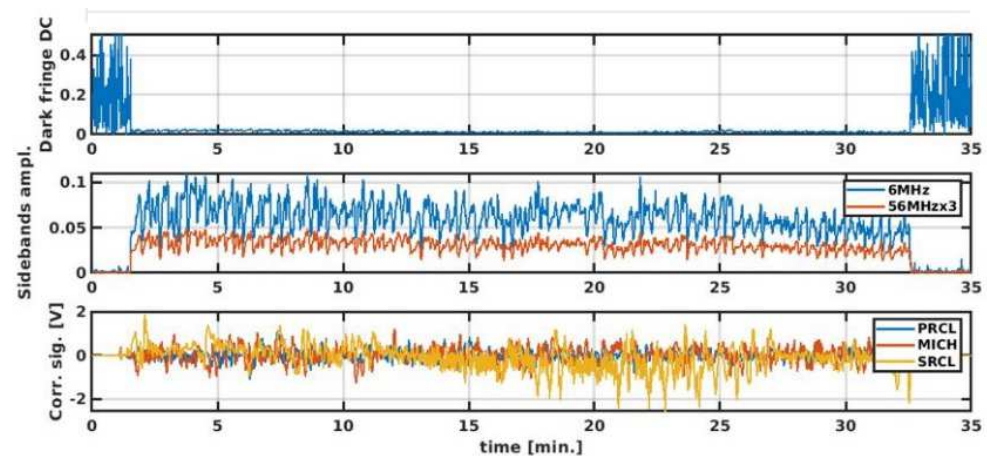

Lock acquisition LIGO & Virgo

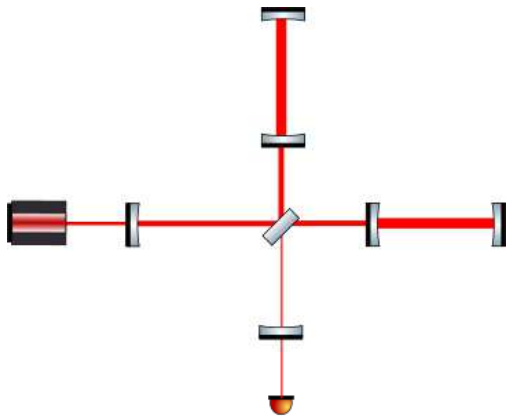

Bring back the resonance of the arms to the IR, having all the dofs controlled.

5 dofs: CARM, DARM, MICH, PRCL and SRCL

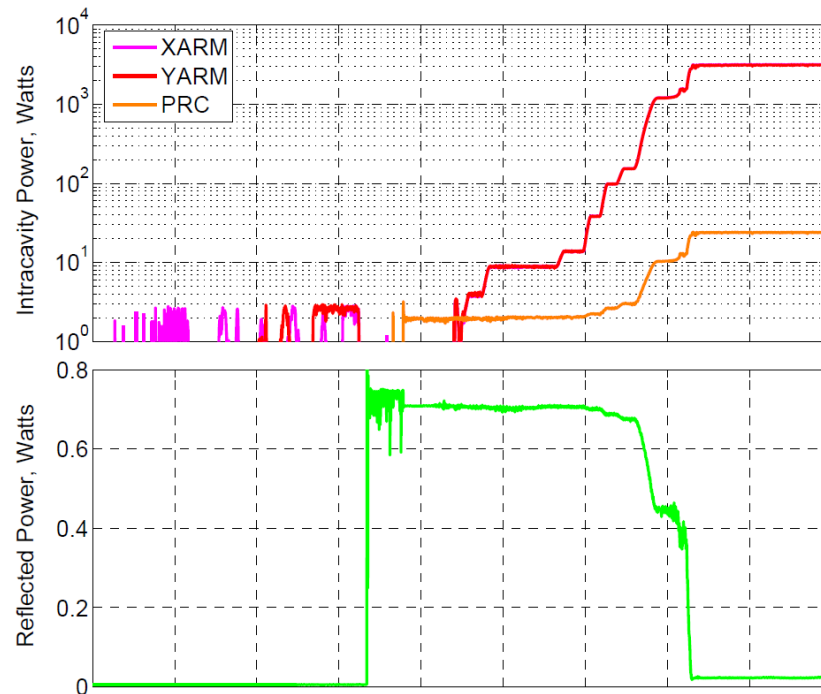

D. Martynov PhD thesis

Alignment in a cavity

When a misalignment in a cavity is present, the generation of Higher order modes (HOMs) occurs.

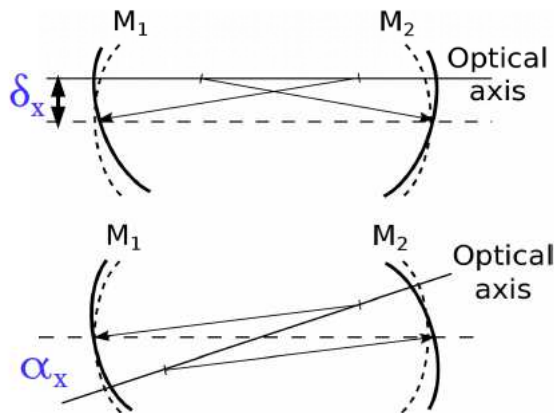
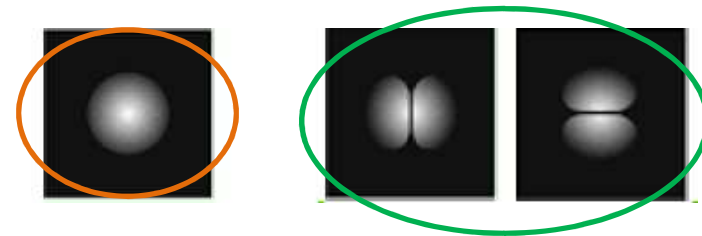

$$E(x + \delta_x) \approx A \cdot [H_0(x) + \frac{\delta_x}{w_0} \cdot H_1(x)]$$

$$E(x + \alpha_x) \approx A \cdot [H_0(x) + i \cdot \frac{\alpha_x}{\theta_d} \cdot H_1(x)]$$

(*) D. Z. Anderson, "Alignment of resonant optical cavities", Appl. Opt. 23 (1984) 2944-2949.

What is the effect of a misalignment?

The main effect of a misalignment in a cavity^(*) is:

- **Geometrical length variation** (the variation of cavity length due to the displacement of the cavity axis (easily recoverable with the longitudinal lock))
- **Power loss** due to the generation of HOMs (the cavity does not let circulate the HOMs, accordingly to finesse and cavity stability)
- strong modification of the longitudinal error signal (for low stability cavities)

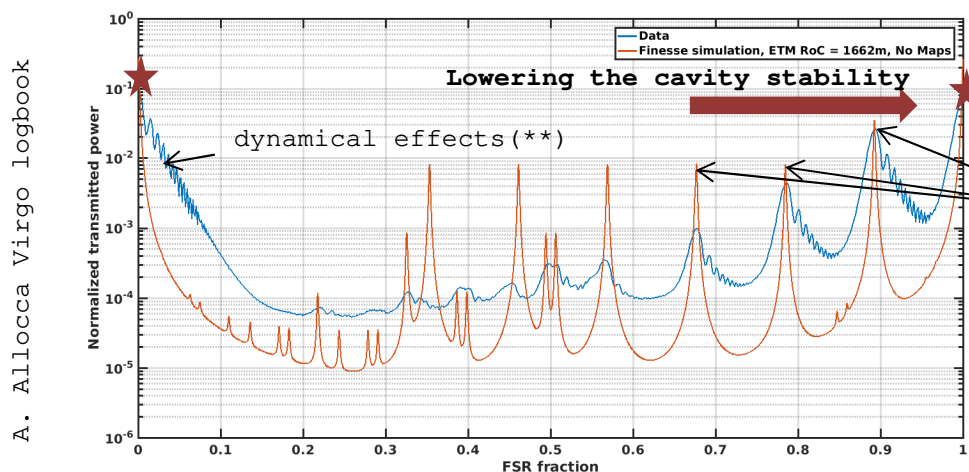

HOMs resonances, the frequency position depends on the cavity geometry. Lower is the stability closer their resonance will be with the TEM00 (fundamental mode)

(*) A.E. Siegman, "Lasers", University Science Books, Mill Valley, 1986.

(**) D. Bersanetti, et.al. "New algorithm for the Guided Lock technique for a high-Finesse optical cavity". Astropart. Phys. 117, (2020)

How to sense misalignments?

The sensing of a misalignment can be performed by taking advantage from the generation of the TEM 01/10 itself, by using a quadrant split photo-detector. Analogously to the longitudinal error signal, the alignment error signal comes from the beating of the 00 of the carrier and the 01 of the sidebands and viceversa(*)

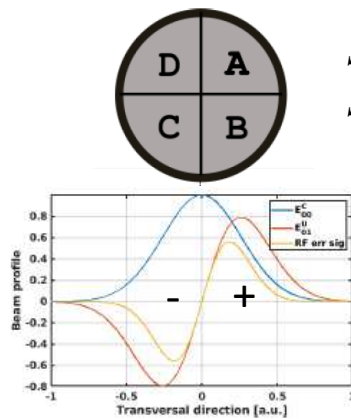

$$S_{hor} = (A+B)-(D+C)$$

$$S_{ver} = (A+D)-(C+B)$$

In order to disentangle the tilt and the shift of the cavity axis two QPDs will be used to image two different position of the cavity axis (Near field i.e. The waist position, and the Far field)

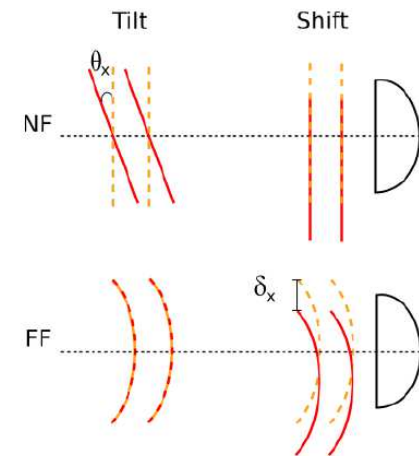

(*) E.Morrison, B.J.Meers, D.I.Roberston, H.Ward
 "Automatic alignment of optical interferometers", Applied
 Optics Vol.33 No.22, 1994

Important effect for alignment: Sidle-Sigg radiation pressure effect

In a high power cavity the laser beam acts as a spring between the two mirrors (torsion pendula) modifying the overall opto-mechanical TF.

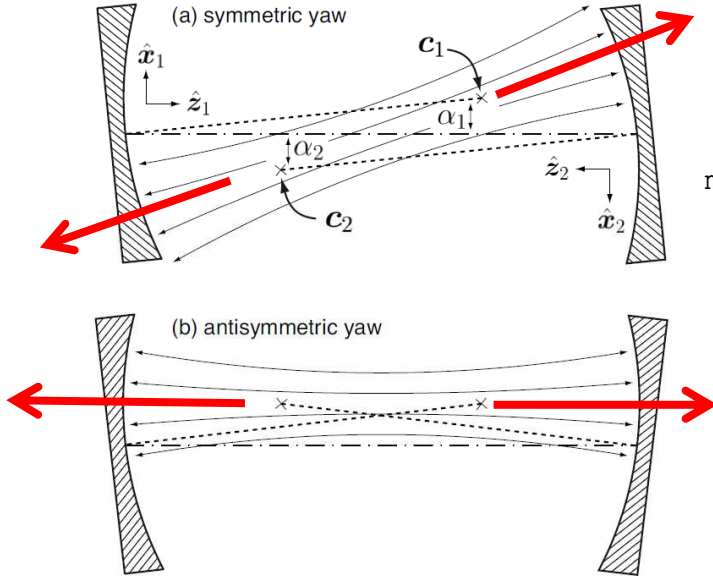

The laser beam apply a torque against the misalignment, making the system **harder** to be misaligned

The laser beam apply a torque towards the misalignment, making the system **softer** to be misaligned

(*) D. Sigg et al., Phys. Lett. A 354 3 (2006) 167-172.

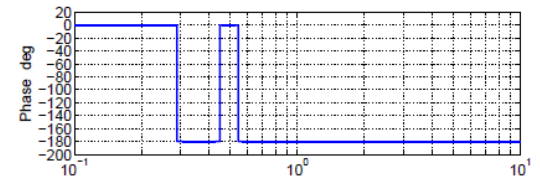
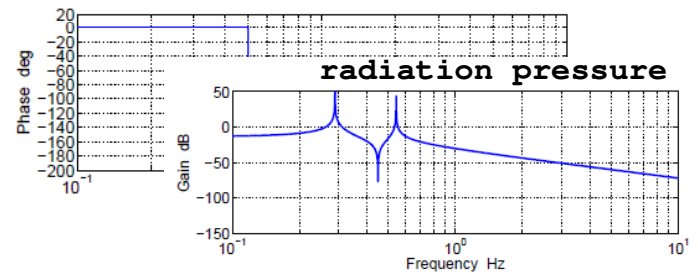
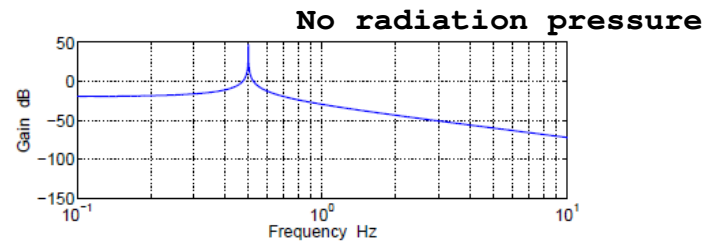

Other defects that can spoil the ITF performances

The alignment is not the only defect in the spoils the interferometer performances.

Cold defects: all the deviations from ideal optical configuration due to lack of accuracy in the manufacture (different radius of curvatures for mirrors, etc...)

Thermal effects: all the modifications to the optical configuration due to the heat produced by the high amount of circulating power.

LIGO vs Virgo

LIGO

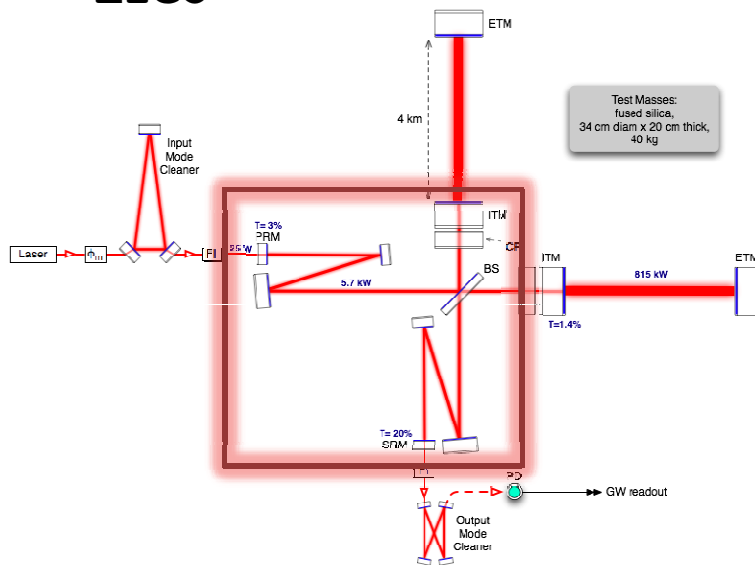

LIGO has much longer recycling cavities to have STABLE recycling cavities (which can filter out the HOMs generated by the defects).

Virgo

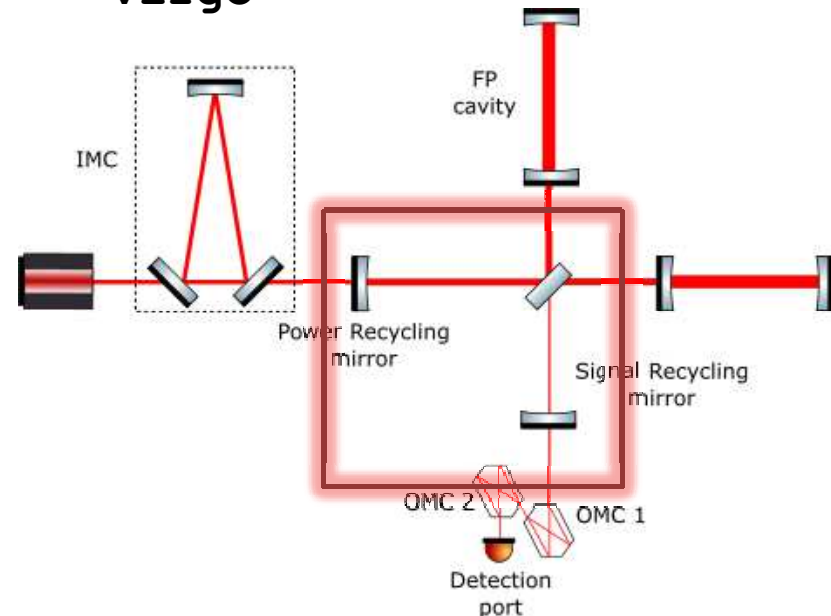

Virgo shorter recycling cavities, nearly unstable (called marginally stable cavities). The HOMs are circulating together with the fundamental mode. Defects have stronger impact

Cold/Hot defects compensation

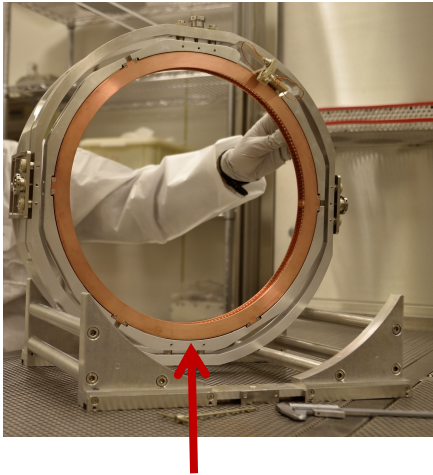

The "Ring heater" is a copper ring that heat up the back face of the mirror to stretch it to change the RoC

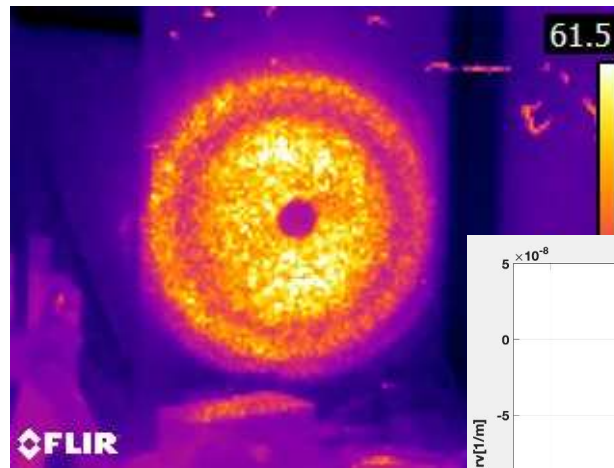

The CO₂ laser heats the "mirror" where it is not heated by the laser beam

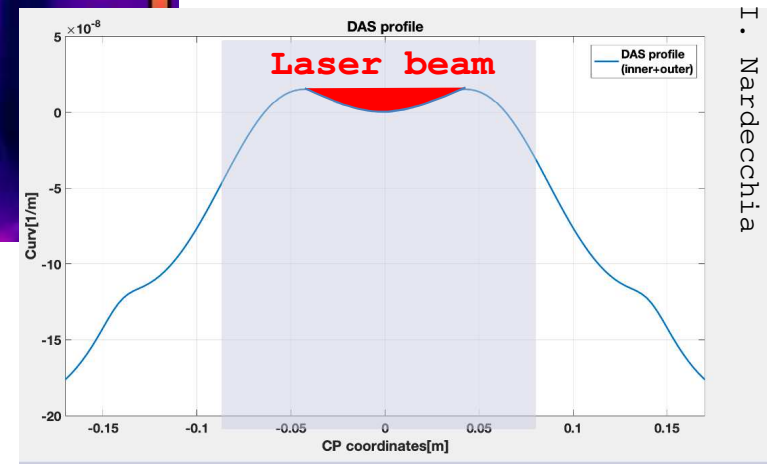

A. Rocchi et al., "Thermal effects and their compensation in Advanced Virgo", Proceedings, 9th Edoardo Amaldi Conference on Gravitational Waves - Cardiff, United Kingdom, 2011,

Tuning of the compensation system

Example of tuning of the thermal compensation system in Advanced Virgo+. As all for the "knobs" available to tune the interferometer parameters the initial tuning is done starting from simulation and the fine one is done directly on the machine

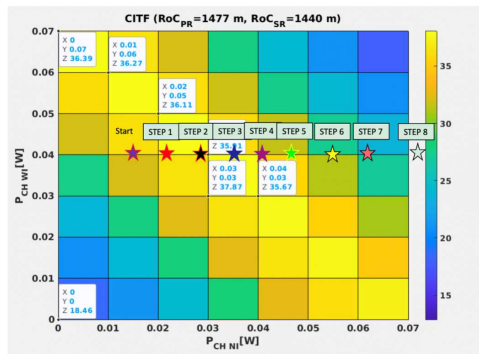

I. Nardecchia

<https://logbook.virgo-gw.eu/virgo/?r=51373>

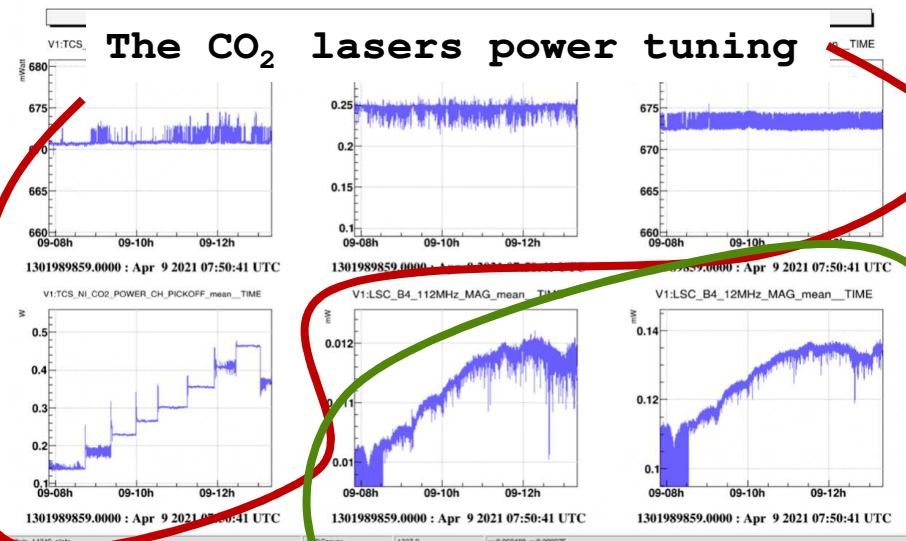

Sidebands power in the recycling cavities

Commissioning and sensitivity improvement

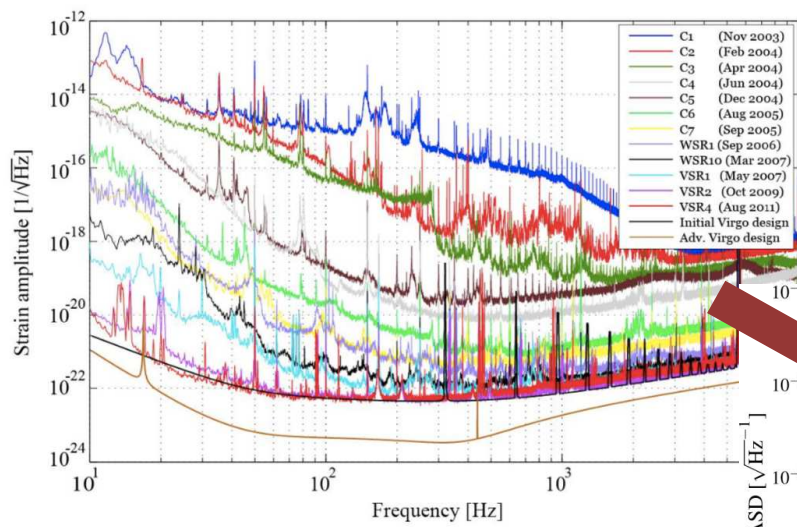

Commissioning is long... It took years to improve the sensitivity to be able to detect gravitational waves

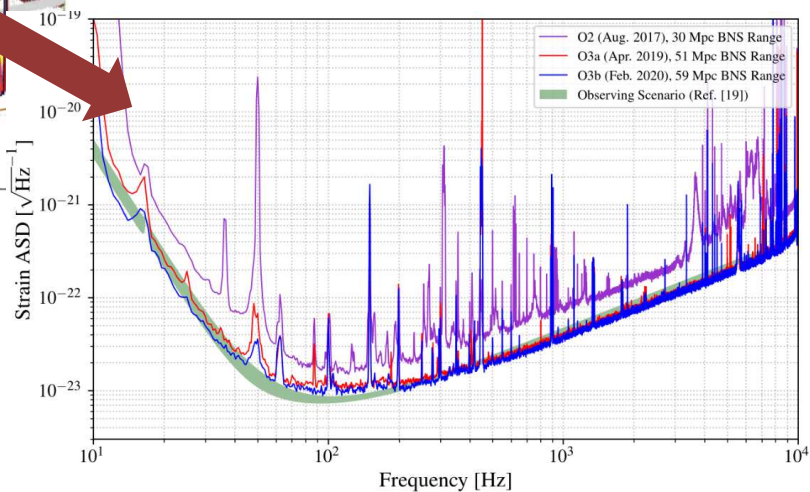

What's next: 3g detectors

Improving the present 2g detectors: see R. Flaminio presentation

And then...

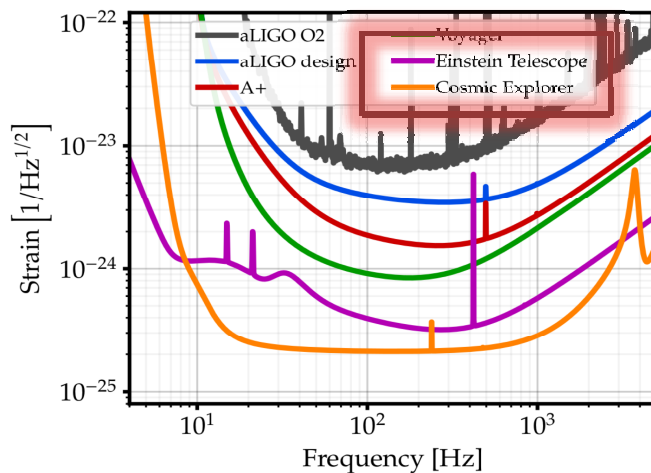

- **Einstein Telescope:** 10 km, xylophone configuration, cryogenic, underground.
- **Cosmic Explorer:** LIGO scaled to 40 km

See A. Freise presentation

Bibliografy

- A.E. Siegman, "Lasers", University Science Books, Mill Valley, 1986.
- Peter Saulson, *Fundamentals of Interferometric Gravitational-wave Detectors* 2nd Edition (2017); Singapore: World Scientific Publishing
- B. Abbott, et al., (The LIGO Scientific Collaboration) "Advanced LIGO", *Class. Quantum Grav.* **32** (7): 074001 (2014).
- R. X. Adhikari, "Gravitational radiation detection with laser interferometry" *Rev. Mod. Phys.* **86** (1):121--151 (2014).
- Abbott, B.P. et al. "Prospects for observing and localizing gravitational-wave transients with Advanced LIGO, Advanced Virgo and KAGRA". *Living Rev Relativ* 23, 3 (2020)
- M. Tringali et al. "Seismic array measurements at Virgo's West End Building for the configuration of a Newtonian-noisecancellation system" <https://arxiv.org/abs/1912.08619>
- C. Caves "Quantum-mechanical noise in an interferometer" *Phys. Rev. D* 23 (1981)
- D. Martynov, 'Lock Acquisition and Sensitivity Analysis of Advanced LIGO Interferometers', PhD, California Institute of Technology, Pasadena (2015)
- K. Izumi, S. Dwyer, L. Barsotti, 'Simulation Study for aLIGO Lock Acquisition', LIGO note, LIGO-T1400298-v1
- J. Casanueva, N. Leroy "Auxiliary Laser system: study of the lock acquisition strategy" Virgo note, <https://tds.virgo-gw.eu/ql/?c=14154>
- R.W.P. Drever and J.L. Hall et al. Laser phase and frequency stabilization using an optical resonator. *Applied Physics B: Lasers and Optics*, 13(1), 1983.
- D. Bersanetti, et.al. "New algorithm for the Guided Lock technique for a high-Finesse optical cavity". *Astropart. Phys.* 117, (2020)
- D. Z. Anderson, "Alignment of resonant optical cavities", *Appl. Opt.* 23 (1984) 2944-2949.
- E. Morrison, B.J. Meers, D.I. Roberston, H. Ward "Automatic alignment of optical interferometers", *Applied Optics* Vol.33 No.22, 1994
- A. Rocchi et al., "Thermal effects and their compensation in Advanced Virgo", *Proceedings, 9th Edoardo Amaldi Conference on Gravitational Waves - Cardiff, United Kingdom, 2011*
- D. Sigg et al., *Phys. Lett. A* 354 3 (2006) 167-172.



Questions?

Residual gas noise: Vacuum



Virgo is the largest ultra-high vacuum in Europe, with a total volume of 6.800 m^3 .

The residual gas noise is due to the interaction of the laser beam with the particles which creates fluctuation of the optical path length. To mitigate the residual gas noise the detector is maintained in ultra-high vacuum (residual pressure 10^{-9} mbar).



LIGO is the largest worldwide ultra-high vacuum, with a total volume of 9000 m^3 .

Seismic noise

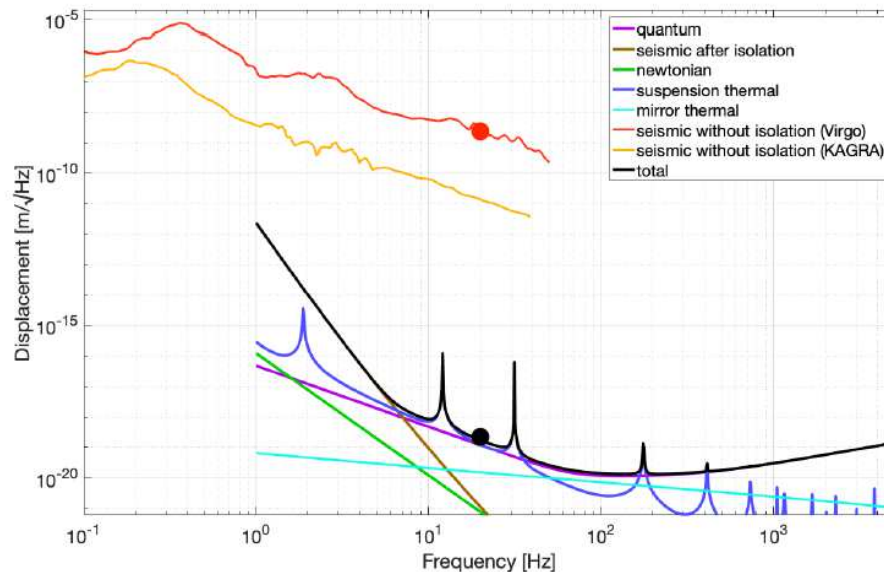

E. Capocasa "Introduction to LIGO/Virgo detectors
(Open data workshop #4)"
<https://tds.virgo-gw.eu/ql/?c=16743>

The seismic natural motion of the optics (due to ground motion) would be at 10Hz $\sim 10^{-9}$ m/ $\sqrt{\text{Hz}}$.

In order to achieve the required sensitivity the seismic noise has to be suppressed more than 10 orders of magnitude.



The mirrors have to be suspended

Seismic noise: suspensions

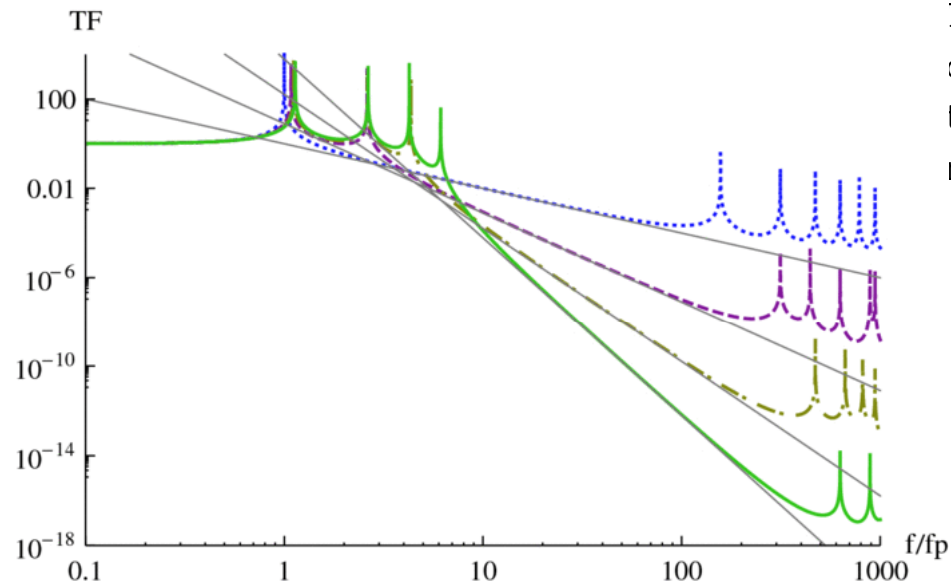

<https://doi.org/10.1063/1.3652857>

The mirrors are suspended by a chain of pendula to isolate the test mass from the seismic noise of their suspension point

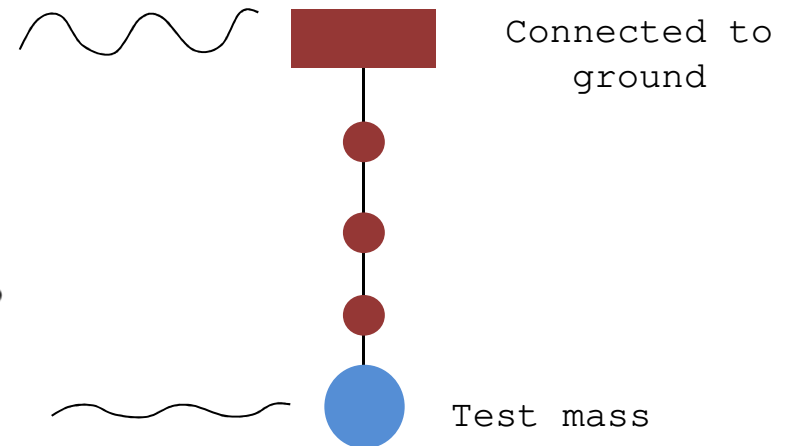

Suspensions in LIGO & Virgo

LIGO

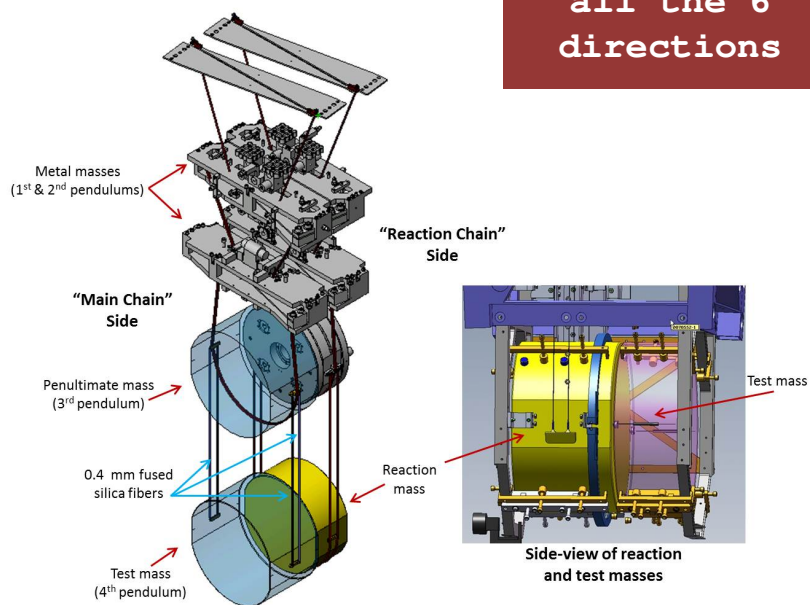

Isolation on all the 6 directions

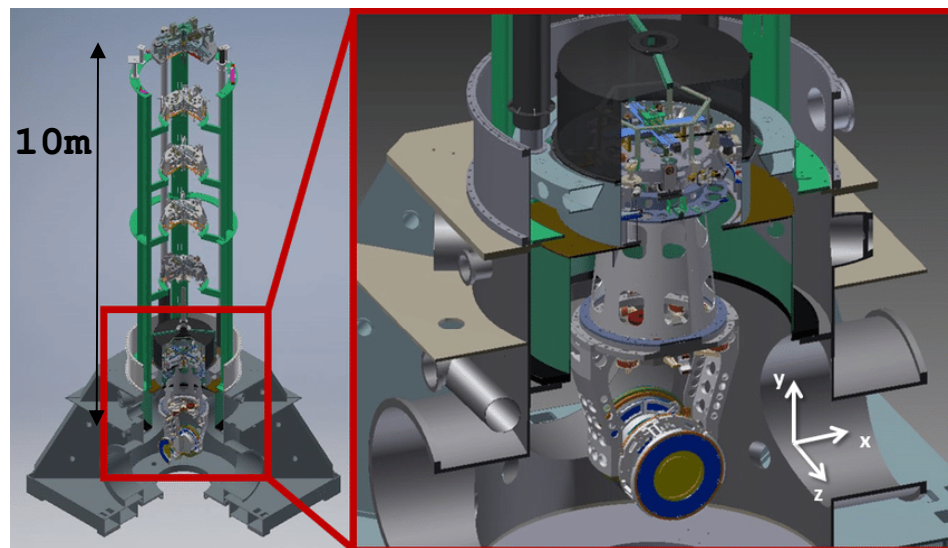

Silica fibers are used for the last stage suspension to reduce pendulum thermal noise

Seismic noise suppression Virgo

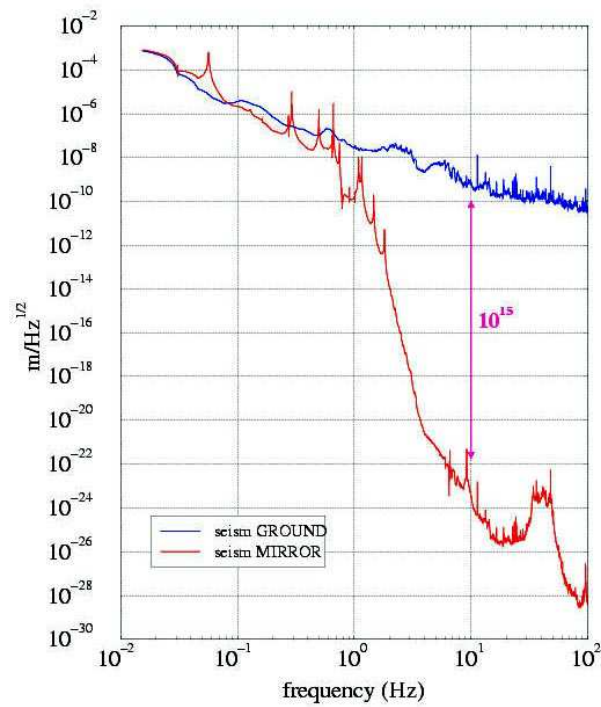

Newtonian noise

The Newtonian noise can not be mitigated by the mirror suspensions since it couples directly to the mirrors.

It is mainly due to the density perturbation in the ground or in the atmosphere

M. Tringali <https://arxiv.org/abs/1912.08619>

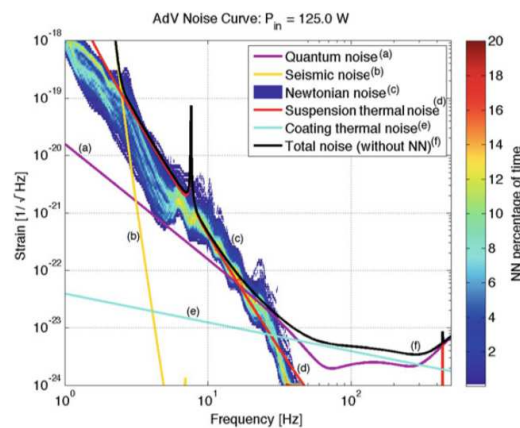
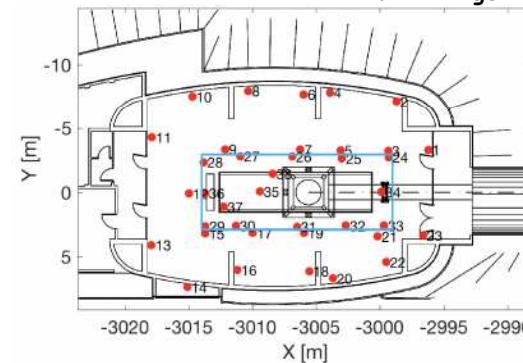

Fig. 13.6 Newtonian noise estimated in [38] for the Advanced Virgo detector. Estimation is based on formula 13.3 and on one week of seismic data taking; in the figure it is indicated the amount of time spent in each level of noise amplitude spectral density



Subtraction of seismic signals from detector data by using an array of seismic sensors installed close to the test masses

Quantum vacuum noise

Radiation pressure noise

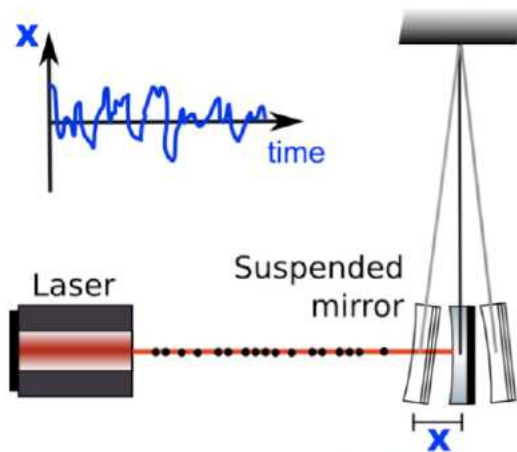

$$h_{rp}(f) = \frac{1}{mf^2L} \sqrt{\frac{\hbar P}{2\pi^3 c \lambda}}$$

P: laser power

Shot noise

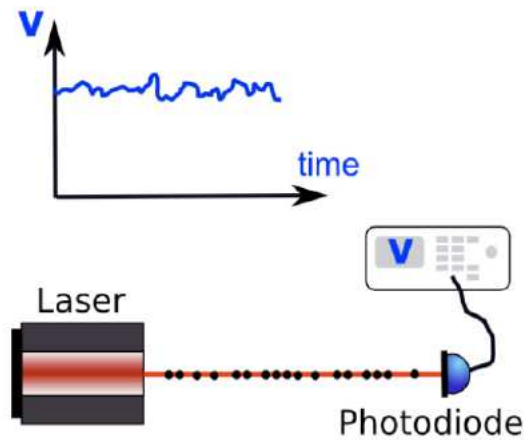

$$h_{sn}(f) = \frac{1}{L} \sqrt{\frac{\hbar c \lambda}{2\pi P}}$$

The photons in a laser beam are not uniformly distributed, but follow Poissonian statistics

M. Vardaro <https://tds.virgo-gw.eu/ql/?c=14766>

Quantum vacuum noise

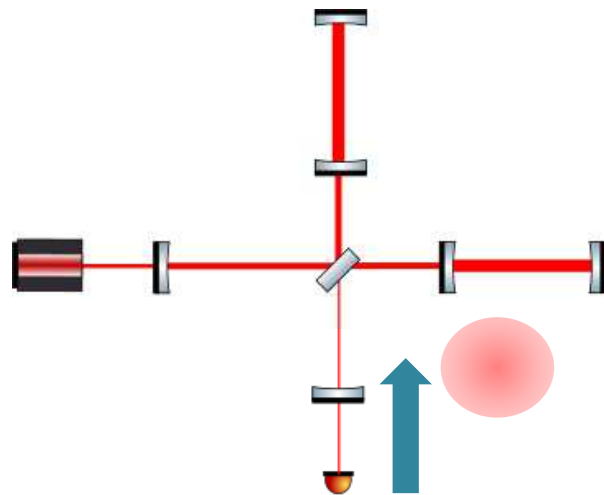

Quantum vacuum noise enters through the dark port.

Vacuum quantum noise is related to the zero-point fluctuations of the electric field in the vacuum state. Such fluctuations exist even though the vacuum state has a photon number of zero.

C.Caves "Quantum-mechanical noise in an interferometer" Phys. Rev. D 23 (1981)

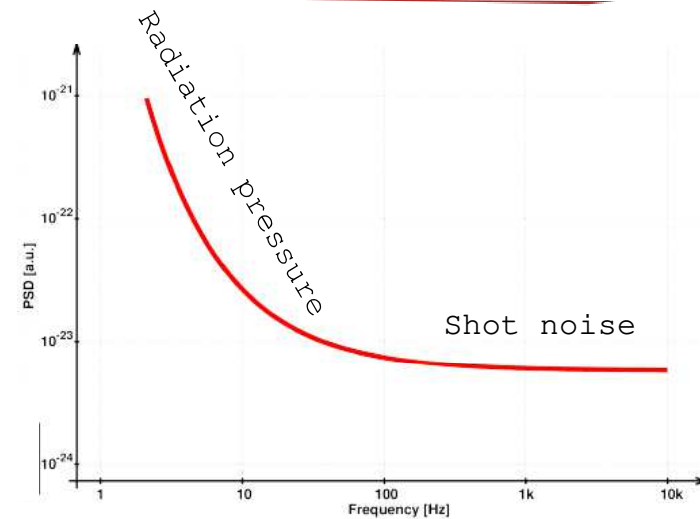

How to mitigate?

By injecting squeezed light

Quantum noise: squeezing

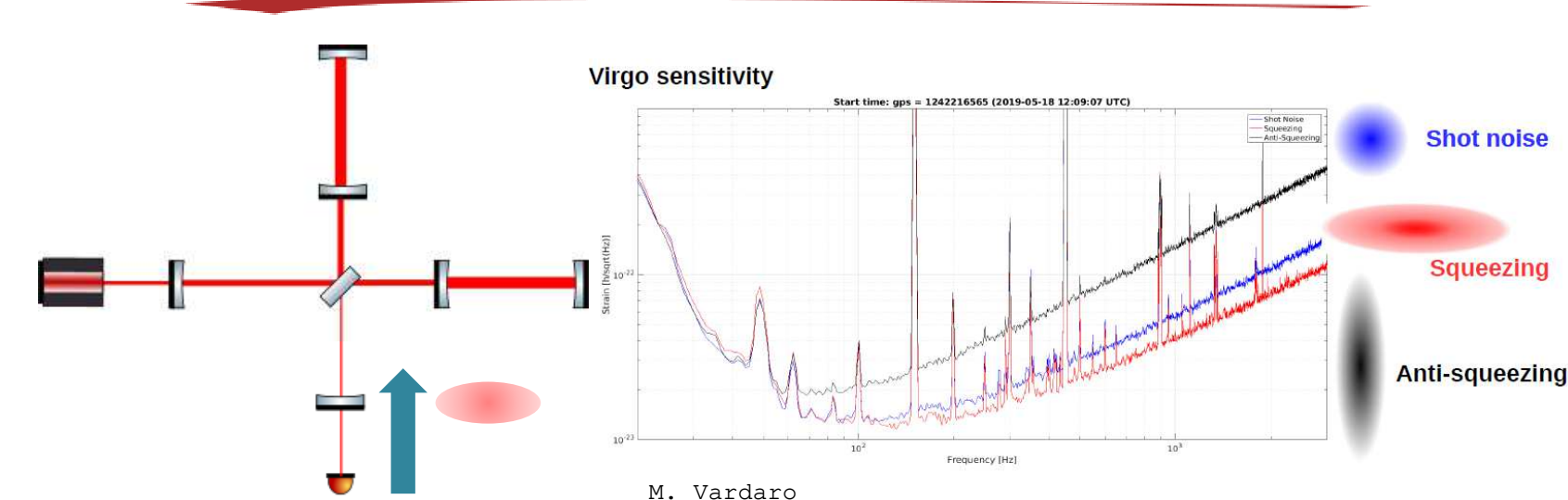

M. Vardaro

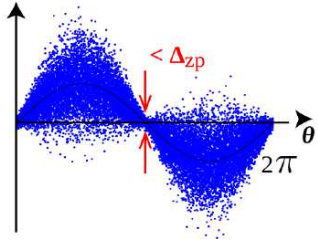

The uncertainty area is the same of coherent states but the noise in one quadrature is decreased whereas the one in the other is increased

Thermal noise

The **thermal noise** affecting gravitational wave interferometers has two different origins. The first one is due to dissipation in the wires used to suspend the test masses; this is the so called **suspension thermal noise**. The second one is due to dissipation processes inside the test masses themselves, the so-called **mirror thermal noise**.



Substrate: fused silica
Coatings: Multilayers of
titania-doped tantala/silica
(TiO₂-doped Ta₂O₅/SiO₂)
Ultralow absorption (<0.5
ppm)

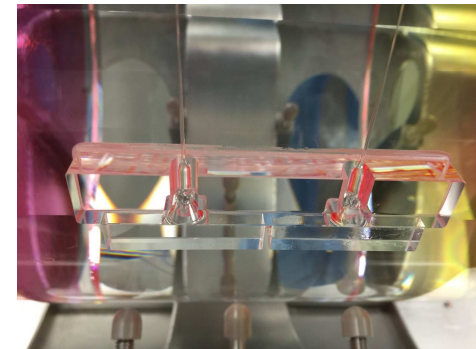

Last stage of suspension
made of silicon fibers