



## **Mechanical Tests of the West End Cryogenic Trap**

VIR-0522A-15

Irene Fiori, Antonio Pasqualetti, Paolo Ruggi  
*European Gravitational Observatory*

3 December 2015

### **Abstract**

We report on mechanical tests performed on the West End cryogenic trap for Advanced Virgo. We measured frequency and Q factor of the first inner tank oscillation modes. We also tested a more efficient version of the dumper.

## 1. Performed tests

Between December 2013 and March 2014, we performed the following tests on the AdV West End Cryogenic Trap [also refer to eLog entry 31386]:

- Measurement of frequency and Q factor of inner tank mechanical resonances (also refer to measurements performed at Nikhef: presentation to VAC meeting by Eric Hennes, March 11, 2013).
- Modification and test of the inner tank dumper to improve its dumping efficiency.
- We measured different configurations:
  - 1) central dumper not installed (inner tank 'free')
  - 2) central dumper installed, standard version
  - 3) modified central dumper (using more rubber)
  - 4) central finger clamped to the external vessel (rubber removed).
  - 5) tank sitting on its transportation feet (screw version).

In **Appendix** we describe the realization of the modified dumper for the inner tank longitudinal motion.

## 2. The setup

We had one tri-axial episensor accelerometer clamped to the inner suspended tank, a second episensor attached to the external vessel, and one tri-axial Guralp 40T seismometer placed on ground next to trap. Unless indicated (case 5 above) the inner tank was suspended by its standard system (air springs) as during normal operation.

Some differences of the tested configuration with respect to 'final' case are:

- 1) the cryotrap was deployed on the WE building floor and un-flanged, not bolted to ground nor flanged to the tube, this could affect the rigidity of the outer vessel and might influence our measurements (see comment afterwards).
- 2) the tank was empty. The estimated weight of empty tank is 525kg, and the maximum liquid nitrogen weight will be around 240kg. Once filled, the tank frequency will be slightly lower than what we measured hereafter scaling roughly as square root of the total tank mass.

Figure 1 shows the cryogenic trap section drawing and the position of our seismic sensors. Figure 2 shows a picture of the modified dumper (see Appendix for the description of the dumper).

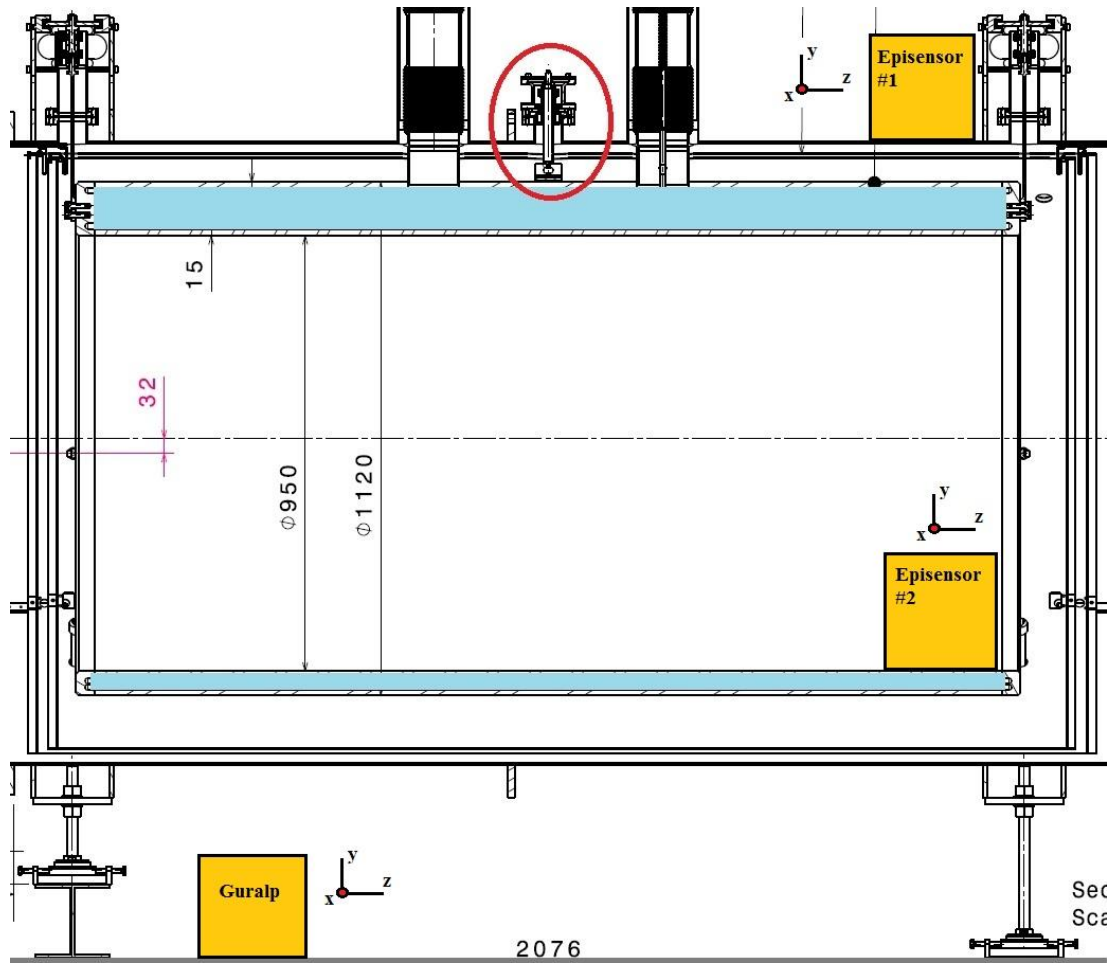

**Figure 1** - Cryotrap drawing with position of triaxial sensors. Refer to Cryo-trap drawings in VIR-0237A-13. For some measurements we moved “Episensor 1” to the inner tank, left side. The air springs and the central finger are shown, while the tank transportation feet are not.

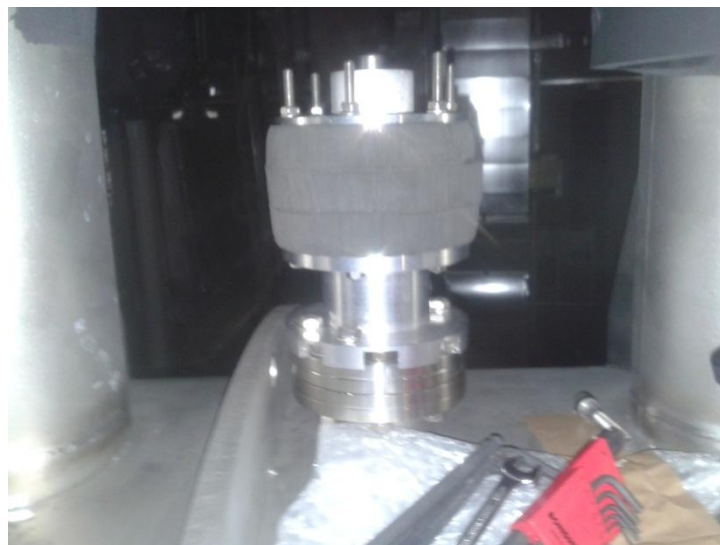

**Figure 2** - Picture of the modified dumper.

### 3. Results

#### 3.1 First longitudinal mode

The frequency and the Q of the first longitudinal (beam direction) oscillation mode of the inner tank was evaluated by measuring the oscillation decay after a perturbation consisting in a gentle kick on inner tank.

The longitudinal episensor signal  $z(t)$  is fit with this function:

$$A_0 \cdot e^{-\frac{\omega_0 t}{2Q}} \cdot \sin(\omega_0 \cdot t + \varphi_0)$$

Where,  $\omega_0 = 2\pi f_0$  is the resonance frequency,  $Q = \tau \pi f_0$  is the resonance quality factor and  $\tau$  is the time for the initial amplitude  $A_0$  to reduce by a factor  $1/e$ ,  $\varphi_0$  is the initial phase. For the fit we used the Matlab function *lsqcurvefit*.

Figure 3 shows the oscillation decay and fit when the dumper is not installed:  $f_0=1.2\text{Hz}$ ,  $Q=61$ ;

Figure 4 shows the oscillation decay fit using the initial dumper design:  $f_0=1.74\text{Hz}$ ,  $Q=31$ ;

Figure 5 shows the oscillation decay and fit with the modified dumper. We measured this twice obtaining:  $f_0=1.61\text{Hz}$ ,  $Q=16$  and then  $f_0=1.67\text{Hz}$ ,  $Q=20$ . The second time we applied a kick 10 times more intense;

Figure 6 shows the case of rigidly clamping the “finger” to the tank without rubber:  $f_0=2.3\text{Hz}$ ,  $Q=60$ ;

Figure 7 shows the case of the inner tank deployed on its supports (i.e. not suspended by the air-springs):  $f_0=4.9\text{Hz}$  ( $Q$  not measured with the fit method).

We notice that the  $Q$  and frequency estimated with this oscillation fit method might in principle be influenced by the external vessel rigidity. Indeed, the external vessel rigidity during the test - it was resting on floor of its feet unbolted and un-flanged - was likely to be different from the final one.

Figure 8 compares the longitudinal motion of the outer vessel with ground motion: we find that the external tank moves rigidly with ground up to at least 5Hz. We can consider it rigid up to this frequency. Therefore, above measured modes are probably not influenced by the outer tank.

However, we also estimated the mode frequency and  $Q$  by measuring the complex transfer function between the two episensors (inner tank and outer tank) longitudinal signals and fitting it with a zero-pole model (we used Matlab function *fit\_zpk*). The TF measures the relative motion of the inner to outer tank and it is thus independent on the external vessel rigidity.

Figure 9 shows the TF results, and table 1 summarizes frequency and  $Q$  of the tank first longitudinal oscillation mode measured with both methods.

We find good consistency between values measured with the two methods, confirming the fact that the external vessel was rigid enough not to influence significantly the inner tank motion.

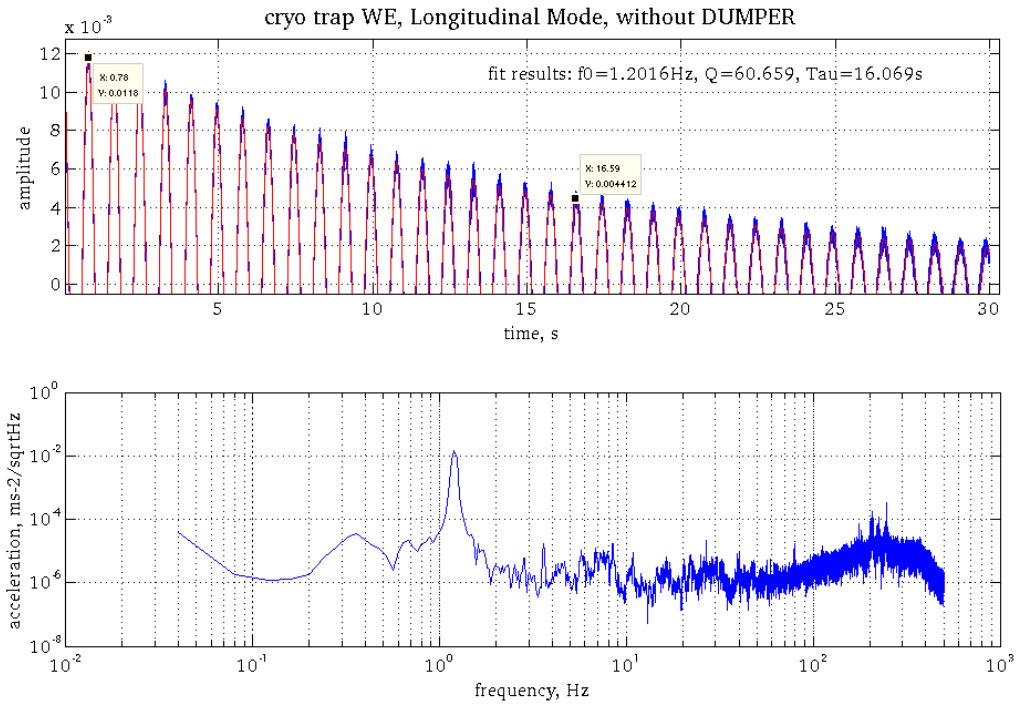

**Figure 3** - Inner tank excited oscillation with dumper not installed. The fit returns  $f_0=1.2\text{Hz}$  and  $Q=61$ .

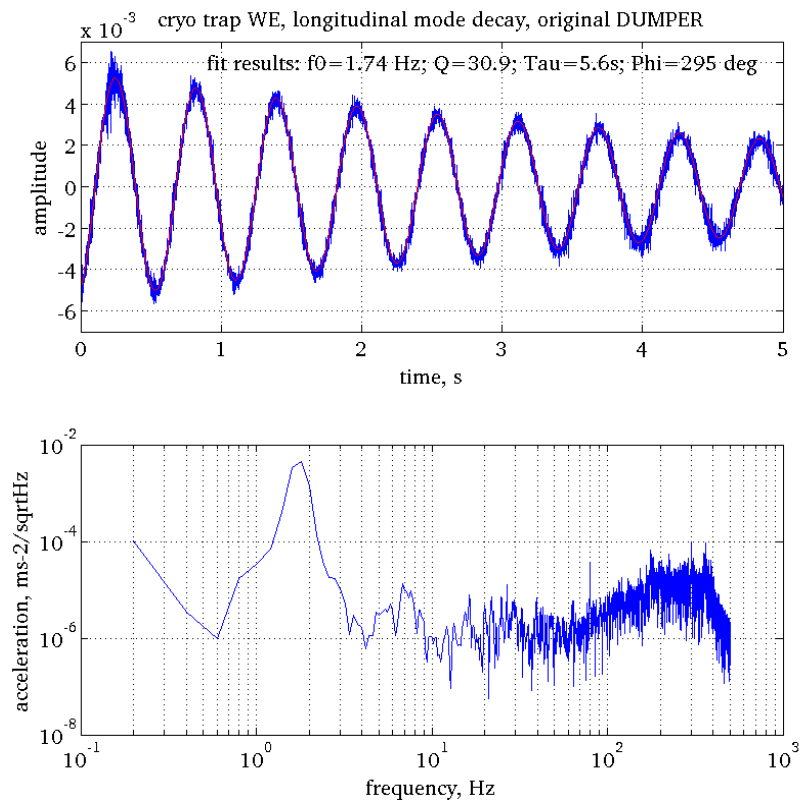

**Figure 4** - Inner tank excited oscillation with standard dumper. The fit returns  $f_0=1.74\text{Hz}$  and  $Q=31$ .

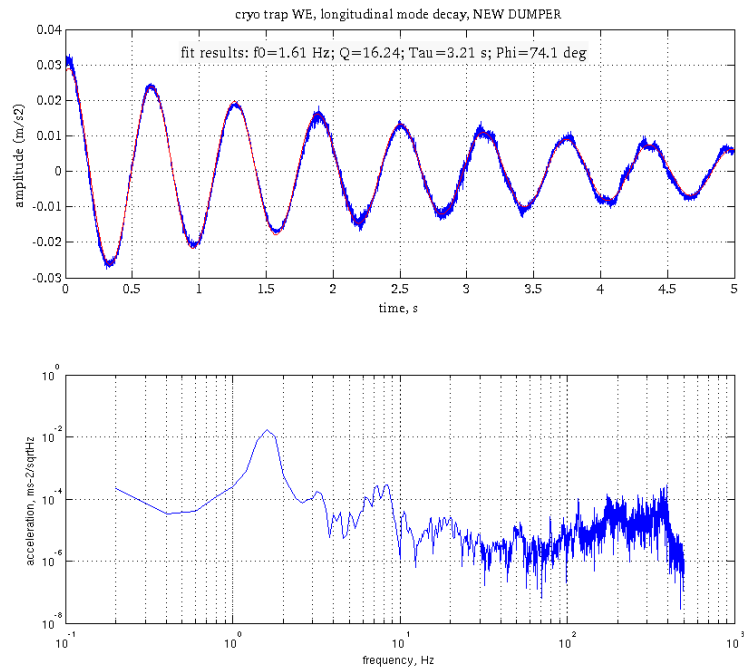

**Figure 5** - Inner tank excited oscillation with the modified dumper. The fit returns  $f_0=1.6$ Hz and  $Q=16$ .

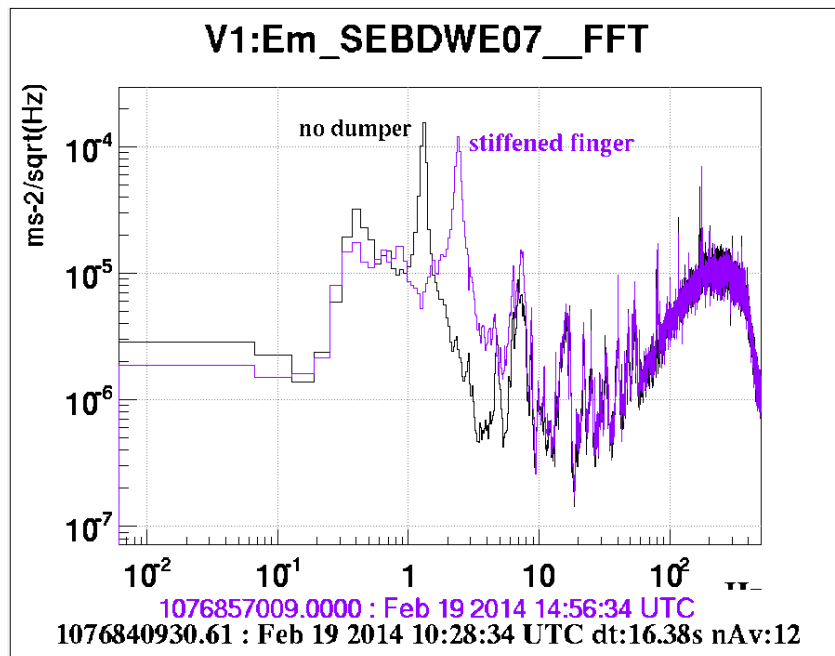

**Figure 6** - Inner tank longitudinal motion without the dumper and with the finger clamped to the inner tank without rubber (purple).

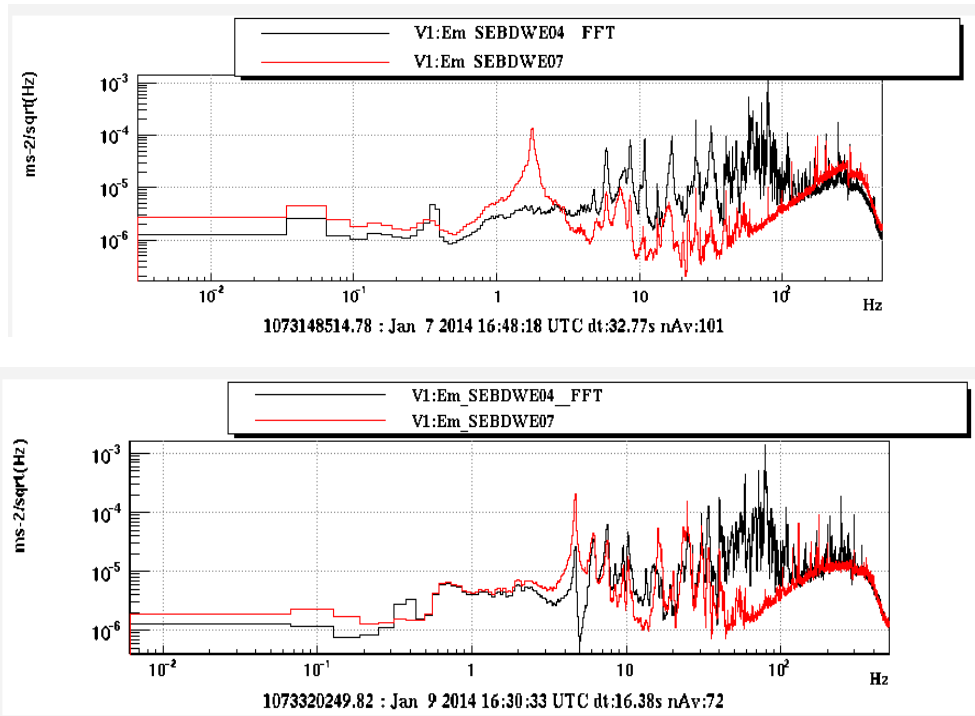

**Figure 7** - Longitudinal motion of the inner tank (red) and outer vessel (black), when the inner tank is suspended with standard dumper (top) and when it is resting on its feet (bottom).

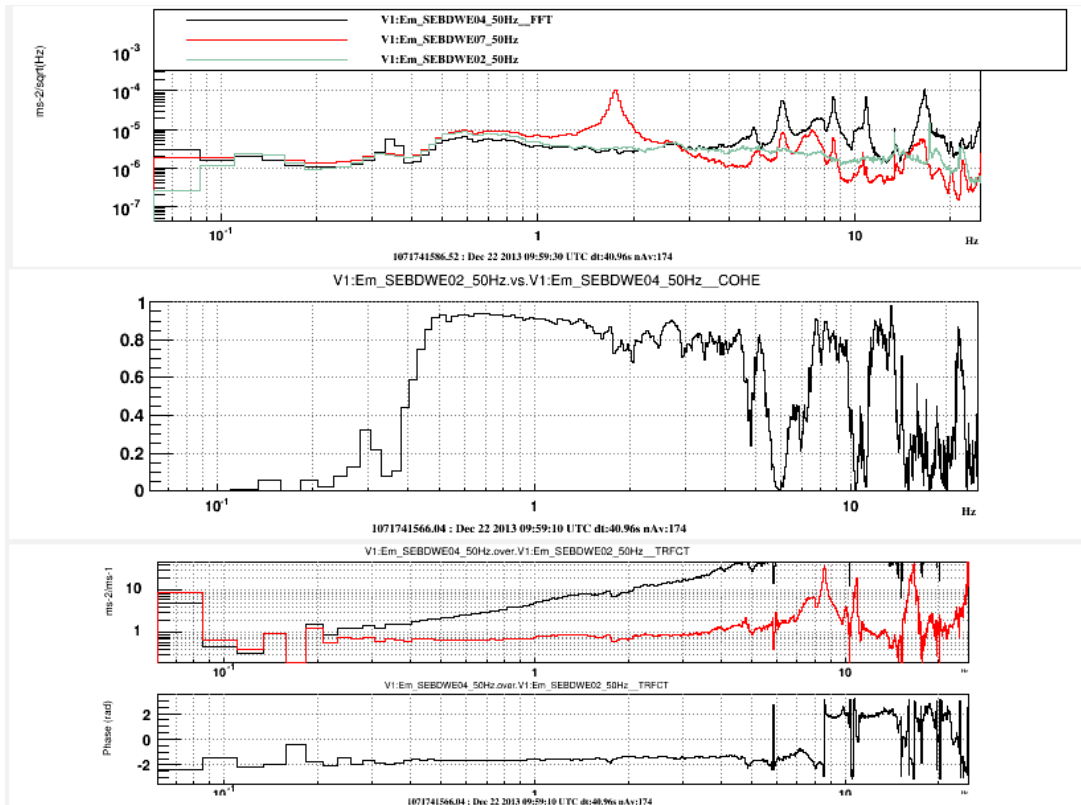

**Figure 8** - Longitudinal motion of the inner tank (red) the external vessel (black) and the ground (green). Bottom plot shows the TF between the outer tank accelerometer and the ground velocimeter (red curve is the FFT primitive of the black one).

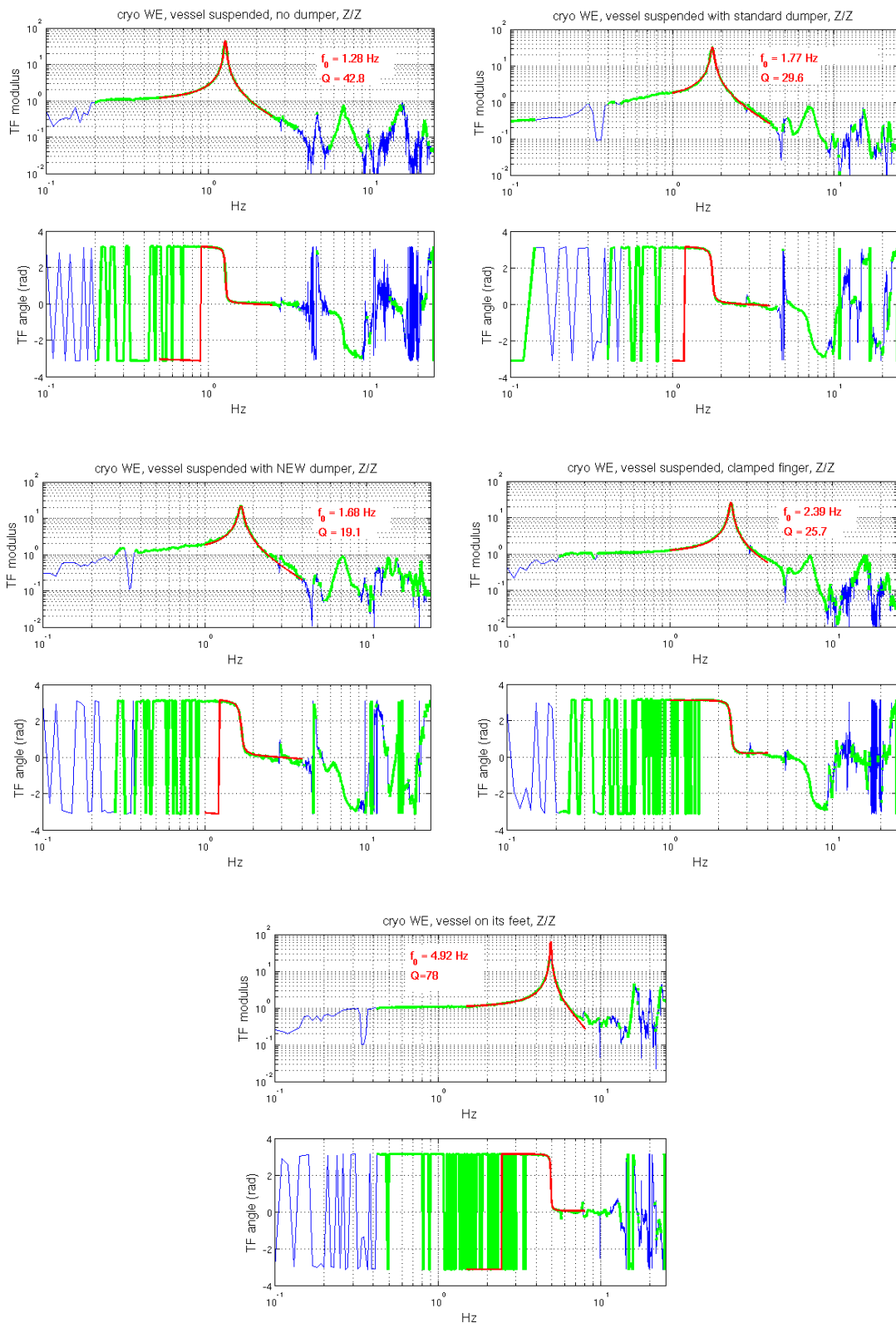

**Figure 9** - Transfer function between the inner and outer tanks, along z (beam line).



Config.	Description	fit ring down		fit TF	
		f <sub>0</sub> (Hz)	Q	f <sub>0</sub> (Hz)	Q
1	Air springs and no dumper	1.2	61	1.28	42.8
2	Air springs and standard dumper	1.74	30.9	1.77	29.6
3	Air springs and modified dumper	1.70	20.6	1.68	19.1
3		1.61	16.24 (*)		
4	Air springs and clamped finger	2.3	N.A.	2.39	25.7
5	Tank deployed on its transportation feet (no air springs)	4.9	N.A.	4.92	70 ± 10

**Table 1** - Measured first longitudinal mode of inner tank (empty). (\*) Oscillation amplitude was 10 times larger.

### 3.2 Other modes

We report hereafter measured transfer functions also for the radial (x) direction and the vertical (y) direction. We measured TF with both the standard dumper (case2 of Sec.1) and the modified dumper (case 3). We also measured the relative motion of the two tank ends in order to help identifying the mode kind.

Figure 10 shows the transfer function between inner and outer vessel along the longitudinal (beam) axis. Figure 11 shows TF between inner and outer vessel along the vessel transverse horizontal axis. Figure 12 shows TF between inner vessel and ground along the vertical direction. Figure 13 shows the TF between the episensors placed at tank two ends.

We are assuming that the outer tank is not participating to the motion. To this end we have checked that this is true for the longitudinal direction at least up to 5Hz (see Sec.3.1). We could not verify this for the X and Y because of problems with some sensor channels. However, it seems reasonable to assume that the outer vessel is rigid up to 5Hz also along the radial direction. For the vertical direction we observe that the outer tank spectrum has no peaks up to about 8Hz (case of standard dumper, in figure 14) and we deduce it must be quite rigid up to this frequency.

With is assumption, and also accounting for measurements preformed at Nikhef, we can tentatively identify first oscillation modes of the empty (full) inner tank as follows:

- along tank longitudinal axis: 1.7 Hz,  $Q \approx 20$  (new dumper) – longitudinal pendulum mode;
- along tank transversal axis: 2.9 Hz,  $Q \approx 45$  (new dumper) – transverse pendulum mode;
- along the vertical and transverse axes: 4.9 Hz,  $Q \approx 25$  – vertical pendulum mode;
- we measure other modes at 5.8 Hz (vertical pendulum?) and 7.3 Hz (vertical pitch?) which however are not present in all measurements.

We can also tentatively assume that these scale as the inverse of the square root of the total inner tank mass, if so we can predict that for the loaded tank (525kg plus 240kg of LN2) these numbers would scale by a factor of about 0.8.

Table 2 below lists all identified modes and compares with measurements reported by Eric Hennes, March 11, 2013.

With standard dumper			
Frequency	Q	Description	@ Nikhef (by E.Hennes)
1.8 Hz	30	Longitudinal pendulum, two ends of the tank move in phase	1.8Hz longitudinal pendulum
2.9 Hz	64	Transverse pendulum, two ends of the tank move in phase	3.3Hz and 4Hz transverse pendulum
4.9 Hz	23	Transverse and Vertical pendulum (two ends move in phase for both)	5.2 Hz vertical pendulum
5.8 Hz	70±10	Vertical pitch, two ends move in anti-phase	
7.3 Hz	14	Vertical pitch, two ends move in anti-phase	7 Hz vertical pitch
With new dumper			
Frequency	Q	Description	
1.68 Hz	19	Longitudinal pendulum	
2.9 Hz	47	Transverse pendulum	
4.95 Hz	30	Transverse pendulum	
Along vertical, we measured no relevant mode, up to at least 10Hz			

**Table 2** - Frequency of first inner tank oscillation modes.

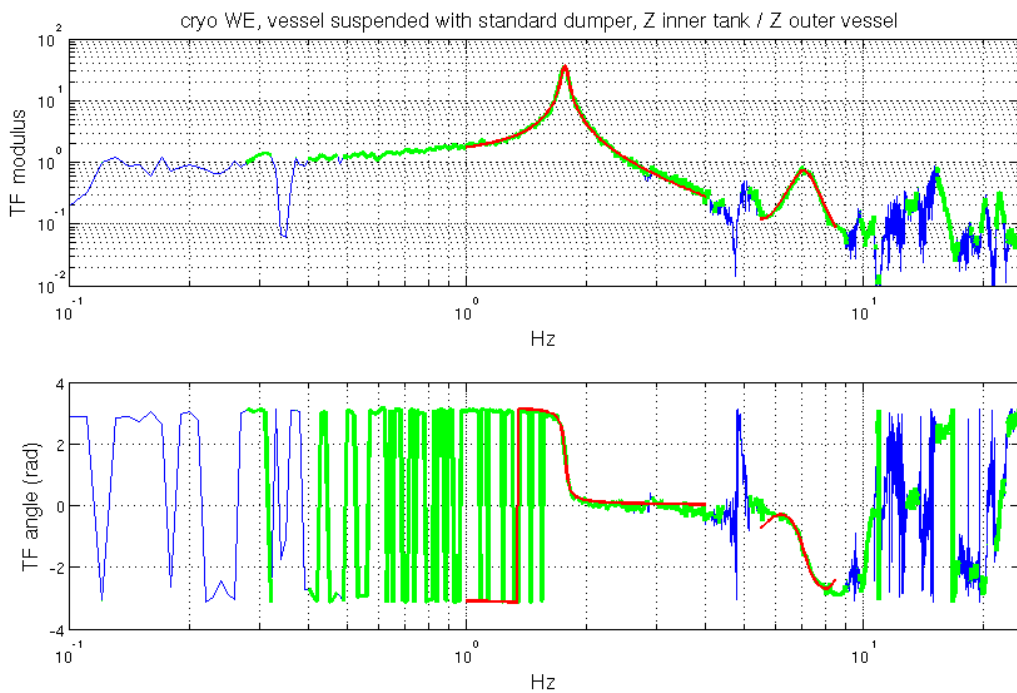

**Figure 10** - Transfer function between inner and outer vessels along the longitudinal (beam) axis.

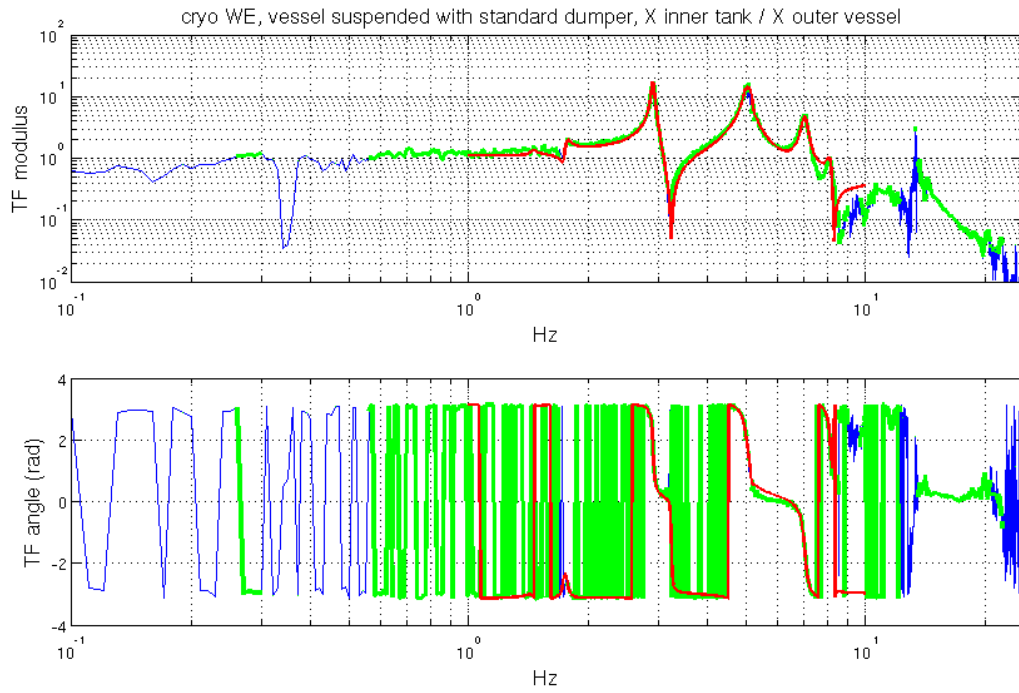

**Figure 11** – Transfer function between inner and outer vessels along the vessel transverse horizontal axis.

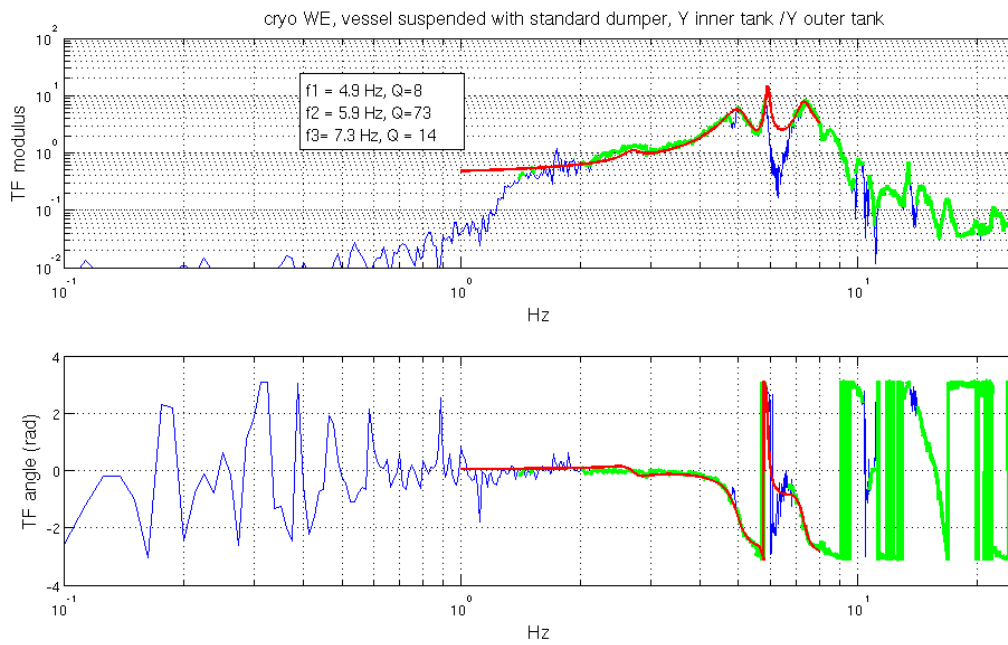

**Figure 12** – Transfer function between inner and outer vessels along the vertical direction.

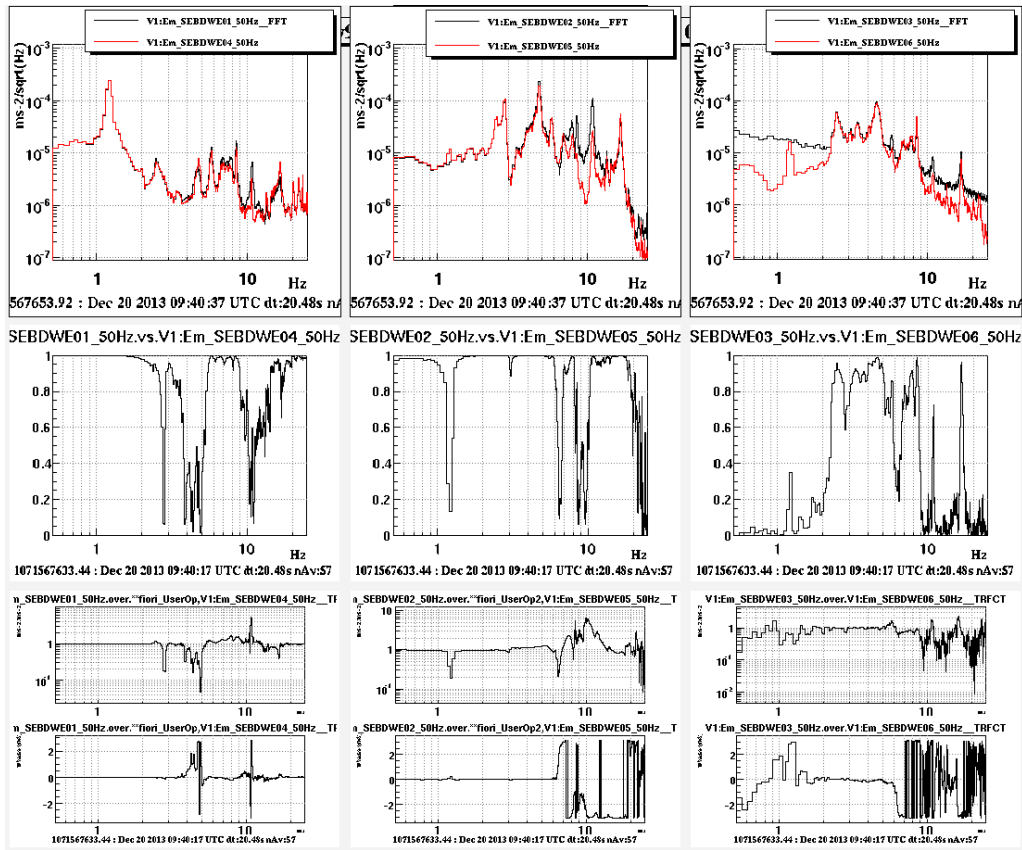

**Figure 13** - Spectra and TF of the two tank ends: left column = longitudinal, middle column = radial, right column = vertical. This measurement was performed for the tank in free oscillation (case 1).

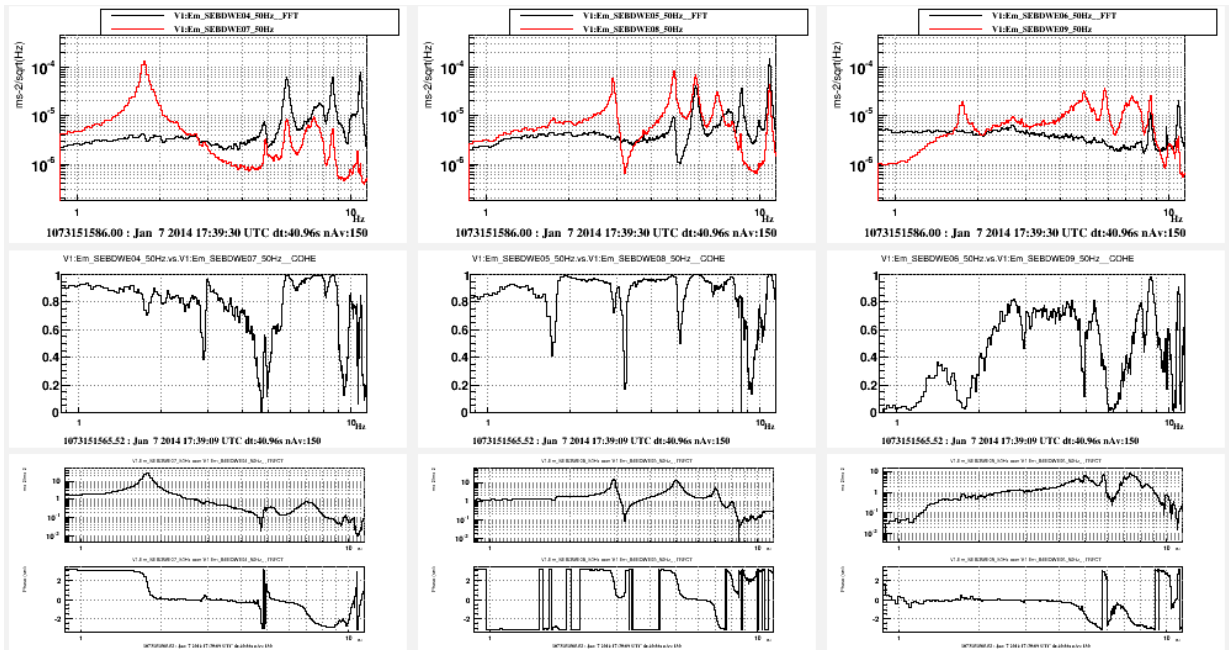

**Figure 14** - Case of standard dumper. Spectra and TF of the inner tank (red) and outer vessel (black) along the longitudinal (left column), the radial (middle column) and the vertical (right column) directions.

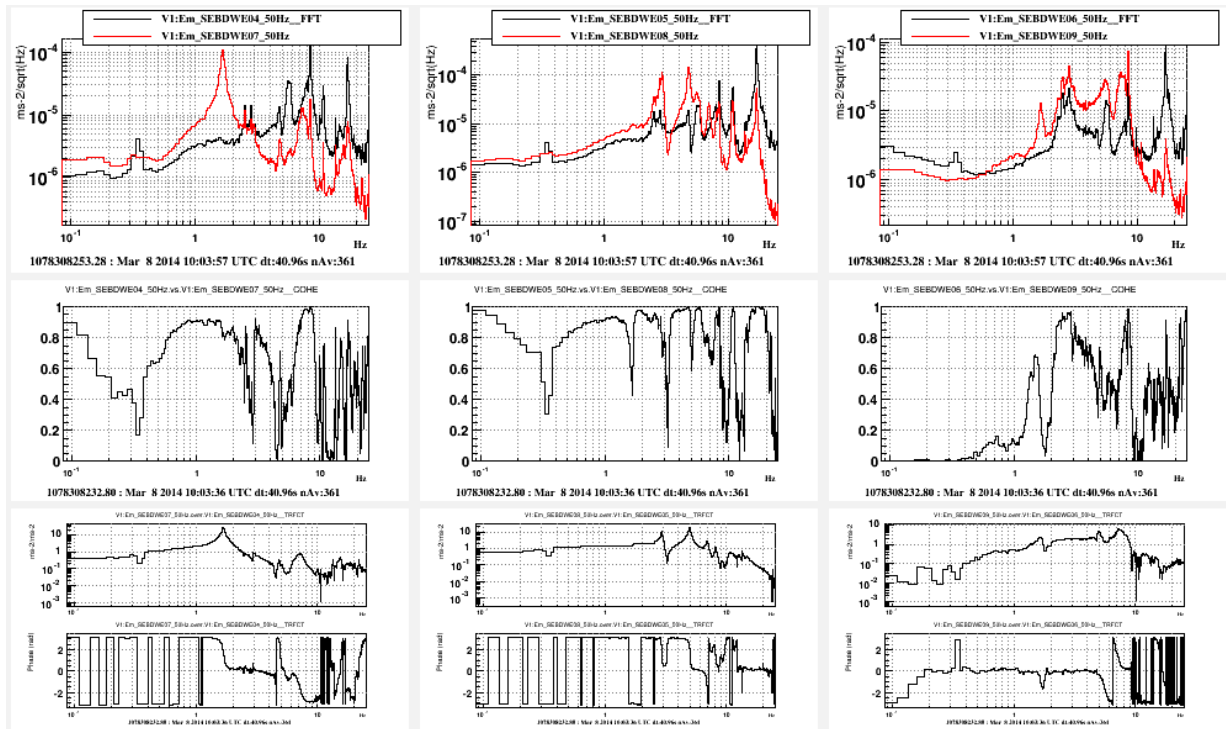

**Figure 15** - Case of modified dumper. Spectra and TF of the inner tank (red) and outer vessel (black) along the longitudinal (left column), the radial (middle column) and the vertical (right column) directions.

#### 4. Conclusions

The inner empty tank oscillates longitudinally at about 1.7 Hz and at about 2.9 Hz along the radial direction. The modified dumper helped reducing the Q from about 30 to about 20 for the 1.7 Hz mode, and from 65 to 45 for the 2.9 Hz mode. These frequencies will likely move to around 1.4 Hz and 2.3 Hz respectively, when the tank will be filled with LN2.

There is not much margin to further improve the dumper or to increase the oscillation frequency of the tank, because of constraints posed by the finger itself, as explained in Appendix. However, in case it will proof necessary to increase the tank oscillation frequency a viable option is to deploy it on its feet (measured 4.9Hz with Q=70) and reduce the Q by inserting properly designed Sorbothane rubber dumpers.

## APPENDIX

We describe the design principle of the suspension of the LN2 tank and the considerations which guided the implementation of a modified version of the viscous-elastic component of the central dumping finger.

We consider only the tank longitudinal motion, therefore all elastic elements we talk about are implicitly considered to be along the cryo-trap longitudinal axis (beam line).

The LN2 tank “suspension system” consists of two pairs of air springs which are loaded with the tank weight and act as low frequency springs in all d.o.f. (see figure 1). In addition, one “finger” is positioned in between the air springs and consists of a steel bar mechanically connected to the in-vacuum LN2 tank. It is possible to apply between the outer end of this finger and the vacuum vessel some kind of viscous material that improves the dumping of the tank, therefore it is called “central dumping finger”.

Figure 16 shows a sketch of the tank longitudinal elastic model. In the case we could assume  $k_F=0$  we just had the parallel of air springs ( $k_A = K_A + i\phi_A$ , where the real part is  $K = M \cdot (2\pi f)^2$  and the imaginary part is the loss angle  $\phi = 1/Q$ ) and the dumper ( $k_D$ ) the complex stiffness sum linearly, giving a total stiffness  $K = K_A + K_D$ , and a dumping factor  $Q = Q_A \cdot Q_D / (Q_A + Q_D)$ . In this case, using a good viscous-elastic rubber with  $Q_D \ll Q_A$  (actually we measured  $Q_A = 61$ , see Table 1 configuration #1) we could make  $Q \approx Q_D$ . Also, properly sizing  $K_D$  we could adjust as we like the frequency of the tank longitudinal oscillation. In practice, we have to account for one additional elastic element which is the finger itself ( $k_F$  in figure 16) and which is placed in series with the dumping element. This  $k_F$  actually limits the maximum stiffness, and thus the maximum oscillation frequency, that can be achieved for the dumping element: roughly,  $K'_D = K_D \cdot K_F / (K_D + K_F) \leq K_F$ . It also impacts on the system total  $Q$ . We measured  $f_F = 1/(2\pi) \cdot \sqrt{(K_F/M)}$  by rigidly clamping the finger to the external vessel, see Table 1 configuration #4, and found  $f_F \approx 2.1$ Hz (from the parallel of  $k_F$  and  $k_A$ ).

With these limitations in mind, we acted in a mostly empiric way: we adopted a good viscous-elastic material, Sorbothane rubber 50-grade (we bought in size of 2.5cm thick foils) and tried to best couple it to the finger.

Sorbothane rubber (see <http://www.sorbothane.com/Data/Sites/31/pdfs/product-guides/Sorbothane-EDG.pdf> and <http://www.vibrationmounts.com/rfq/VM01033.htm>) has very good viscous properties and, if properly mechanically coupled to the moving system, it can perform a very efficient conversion of elastic energy into heat (i.e. achieving dumping factors  $Q$  close to 1).

In our case, “good mechanical coupling” means that we have to make one side of the Sorbothane block well attached to the external vessel while the “opposite” side moves together with the finger bar so that the finger compresses and stretches the rubber during its motion. We used three layers of 2.5cm thick Sorbothane foils cut in the shape of disks with roughly 5cm radius (see figure 2). The finger was passed through a hole in the disks centre. This way we surrounded completely the finger outer end side with rubber along its whole extension.

The Sorbothane rubber was compressed along the vertical direction, between the external vessel flange and one aluminium disk placed on top the rubber layers, by means of feed-through screws with nuts (Figure 1). This compression makes the rubber expanding in horizontal direction pressing it against the finger, so to have a good contact.

With this realization we could achieve a Q dumping coefficient of the tank of about 20.

Actually, it is possible that the coupling is sub-optimal and there is room for improvement. If we insert the measured numbers in the simplified model illustrated in Figure 16, it predicts that by improving the coupling of the Sorbothane while paying attention of not increasing too much the rigidity of the rubber block (e.g. disks of smaller radius) the system Q could reduce further. Indeed, it is possible that this model is too simplistic.

We also mention two additional constraints have to be taken into account in sizing our dumper:

- 1) Percent static deflection should not exceed 20% to avoid hysteresis and non linear working regime.
- 2) Percent dynamic deflection should not exceed 1% to guarantee the rubber works in a linear oscillation regime. To size this, we measure the maximum finger displacement (i.e. the amplitude of tank longitudinal 1.7Hz oscillation when subject to standard environmental conditions) to be about 50µm, consequently a longitudinal rubber thickness larger than 5mm must be used.

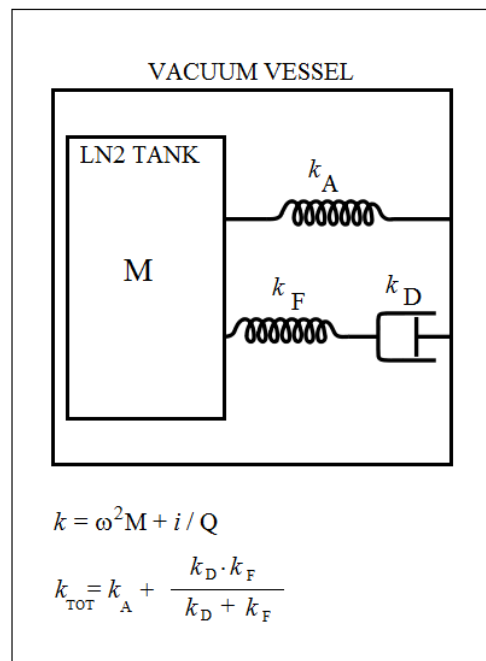

**Figure 16** – Sketch of the viscous-elastic model of the suspended tank with indicated the complex stiffness ( $k = \omega^2 M + i / Q$ ) of elastic components: the air springs suspension ( $k_A$ ) the finger ( $k_F$ ) and the dumper viscous element ( $k_D$ ). Note that air springs support the tank weight while the finger and dumper do not.