

Vincent Germain

June 10, 2016

Noise subtraction with SilenteC



Aim

- Use the auxiliary channels of Virgo/LIGO to predict transient noise (glitches) in $h(t)$
- Mitigate the glitches produced by these noise sources
 - instead of using CAT1 veto → more data to be analyzed
 - instead of using gating → data available for analysis

*History: Matlab code (Silente) inherited
from Gianluca Guidi & Francesco Piergiovanni*

Difficulties

- Non-linearity → frequency of the noise can change from an auxiliary channel to $h(t)$ (up-conversion)
- Orthogonality → do not create “holes” (e.g. by removing a noise twice)
- Safety → do not remove GW signal in $h(t)$

SilenteC

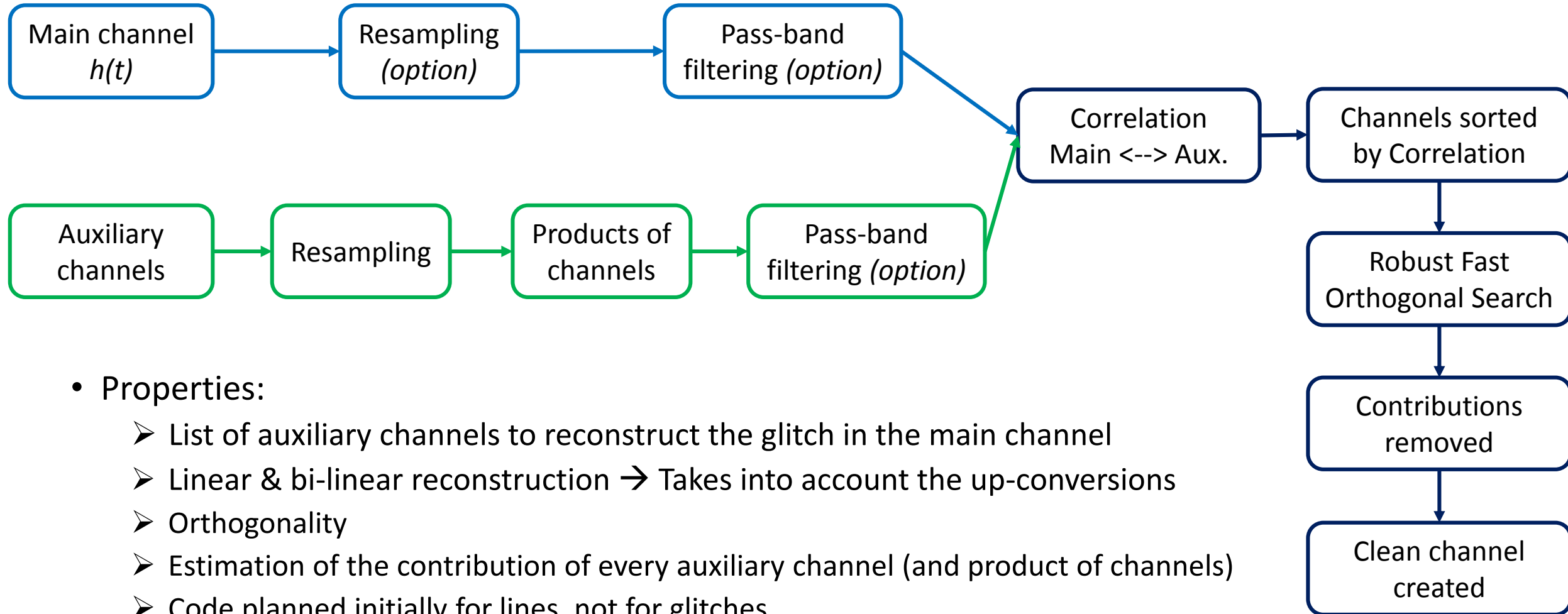

Simulation tool

Auxiliary channels

Line

$$s(t) = A * \sin(2\pi f t + \varphi)$$

Glitch

$$s(t) = A * e^{-\frac{(t-t_0)^2}{(Q/2\pi f)^2}} * \sin(2\pi f t)$$

Noise

$$s(t) = A * \text{randgauss}(0)$$

Creation of the channels *ch1*, *ch2*, ...
ch_i: Combination (**Line**, **Glitch**, **Noise**)

Sampled at
Fs = 2000 Hz

Main channel *chtot*

$$A_i = 1$$

Products of
channels

$$chtot = A_1 * ch1 + A_2 * ch2 + A_3 * (ch_i * ch_j) + \dots$$

Tests with SilenteC

- Main channel: **chtot**
- Auxiliary channel: **ch1, ch2, ...**
- **No resampling & no filtering** of the channels (main & aux.)
- Window: **2 seconds** of data analyzed

gaussian noise

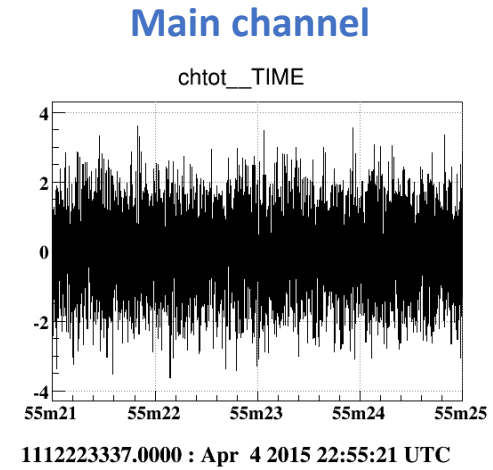
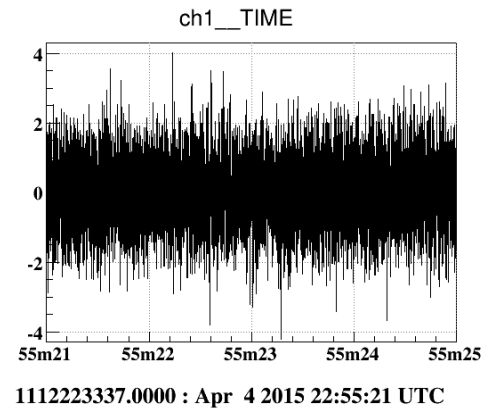
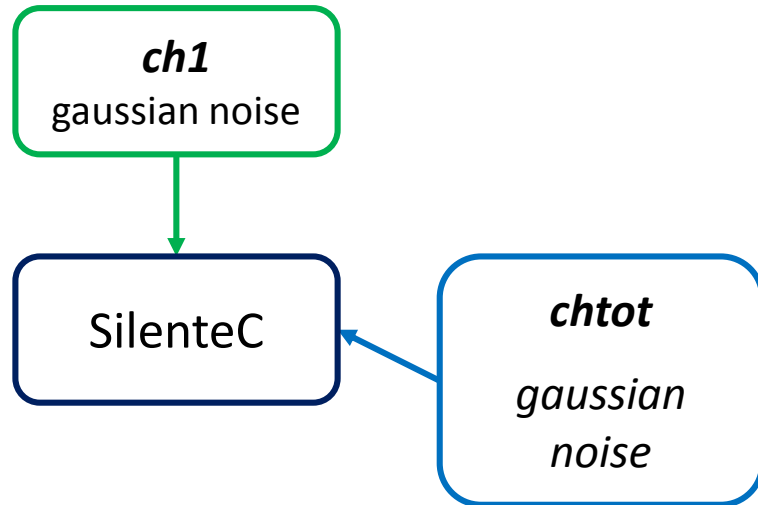

gaussian noise

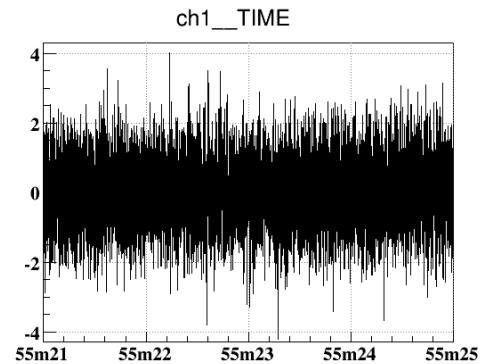
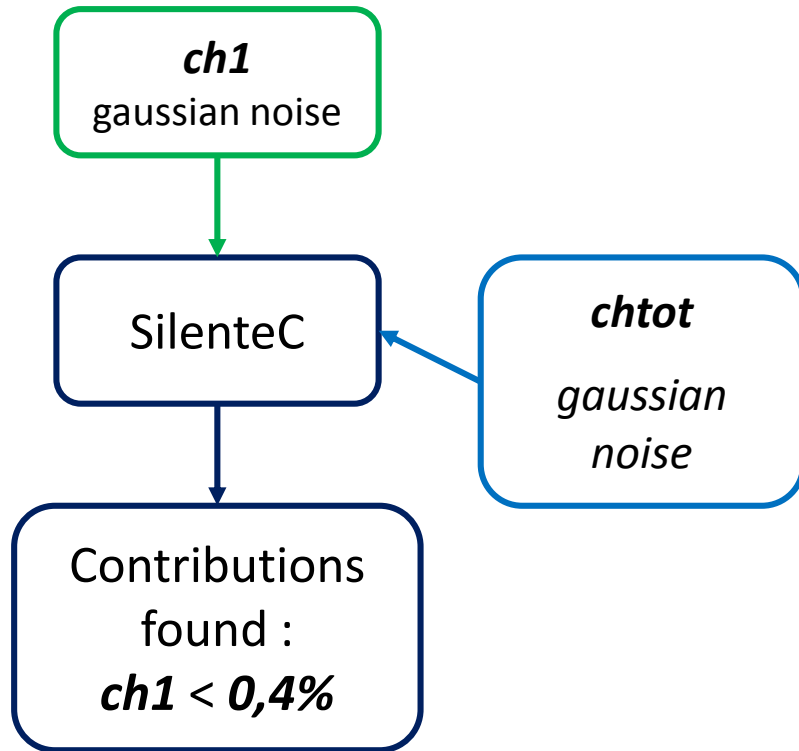

1112223337.0000 : Apr 4 2015 22:55:21 UTC

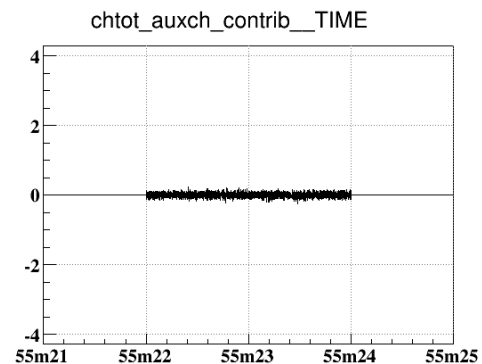

1112223337.0000 : Apr 4 2015 22:55:21 UTC

Contributions

Main channel

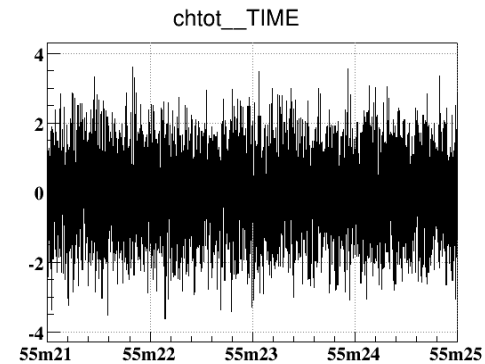

1112223337.0000 : Apr 4 2015 22:55:21 UTC

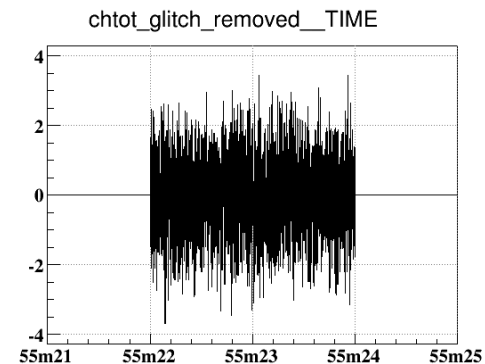

1112223337.0000 : Apr 4 2015 22:55:21 UTC

Cleaned channel
(Main ch. - Contrib.)

glitch

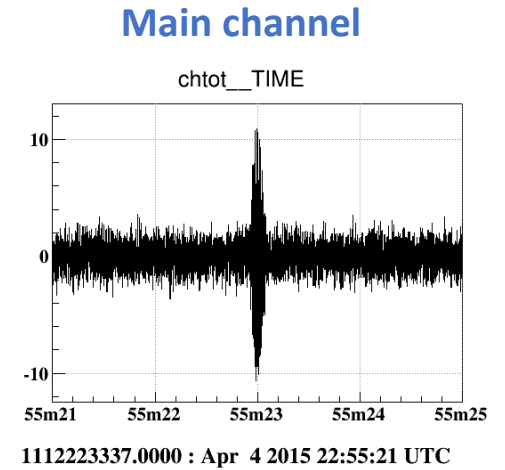
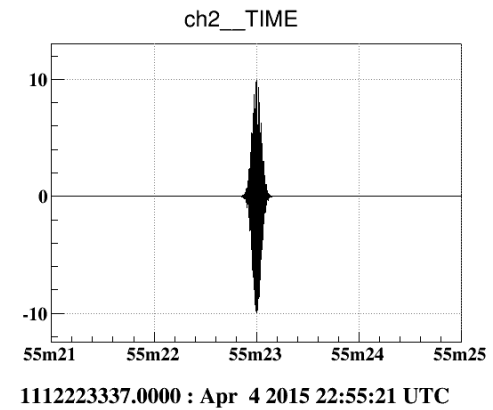
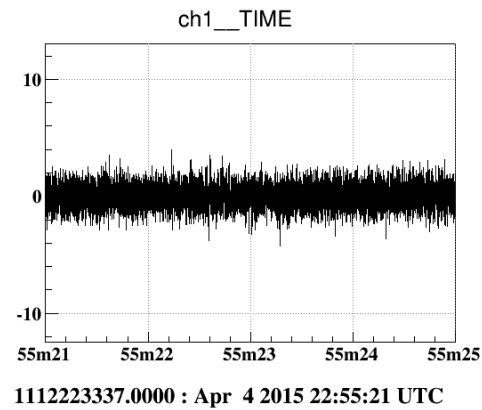
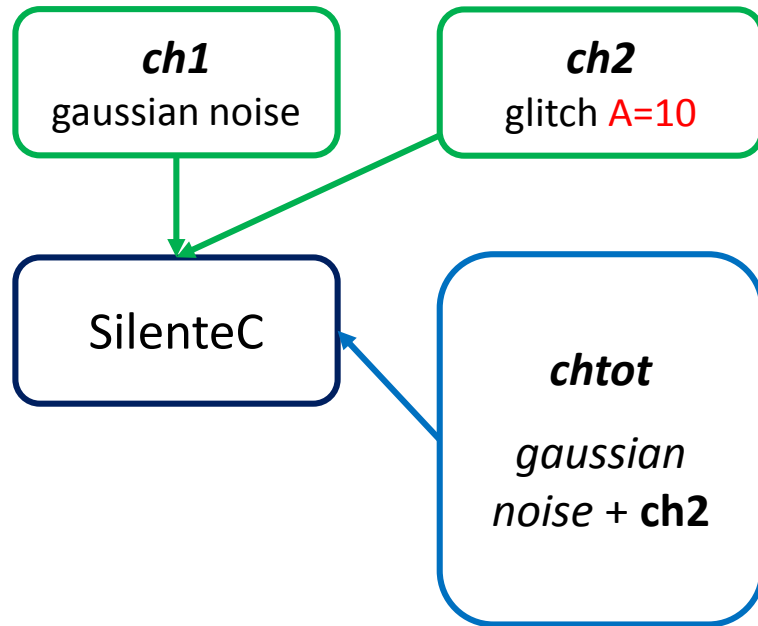

glitch

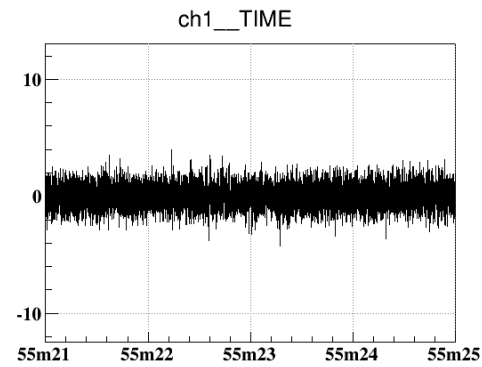
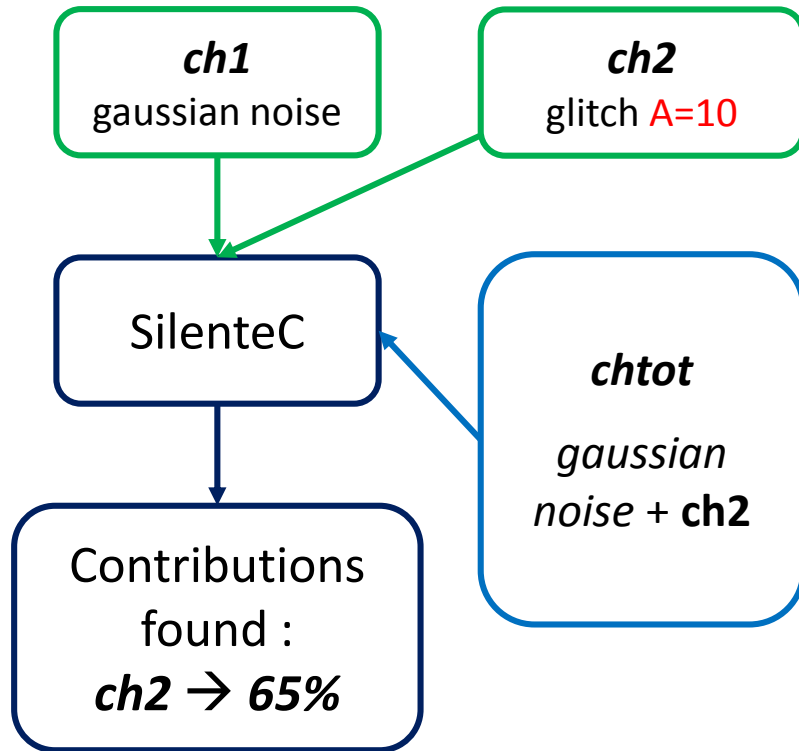

1112223337.0000 : Apr 4 2015 22:55:21 UTC

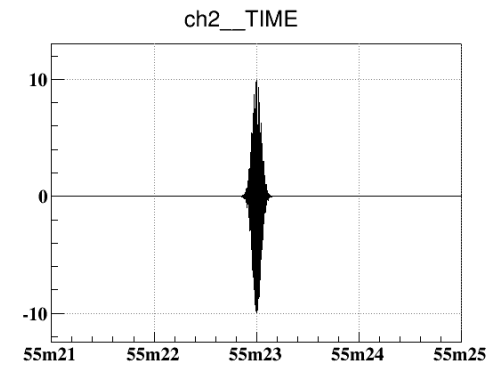

1112223337.0000 : Apr 4 2015 22:55:21 UTC

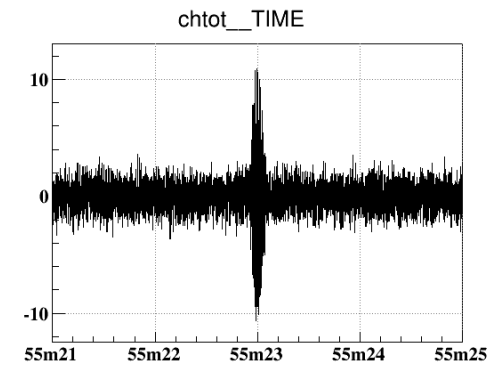

1112223337.0000 : Apr 4 2015 22:55:21 UTC

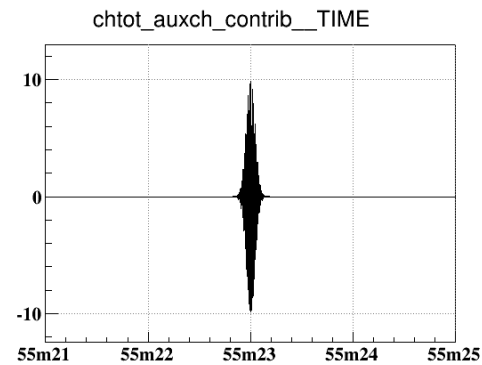

1112223337.0000 : Apr 4 2015 22:55:21 UTC

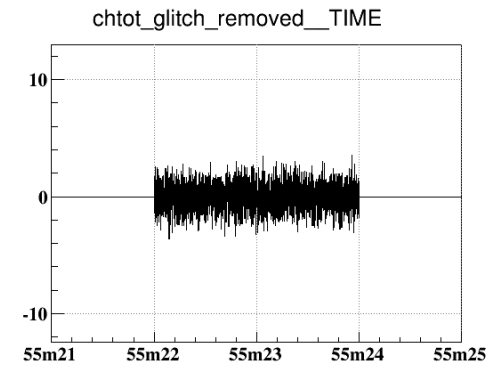

1112223337.0000 : Apr 4 2015 22:55:21 UTC

Contributions

Cleaned channel
(Main ch. - Contrib.)

Main channel

glitch

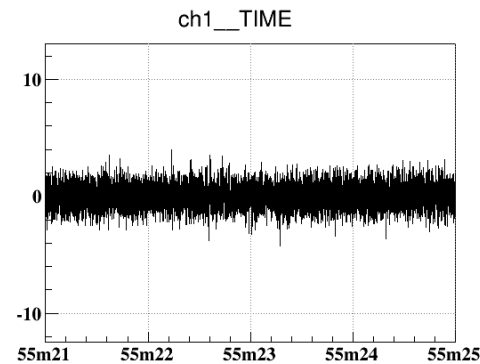
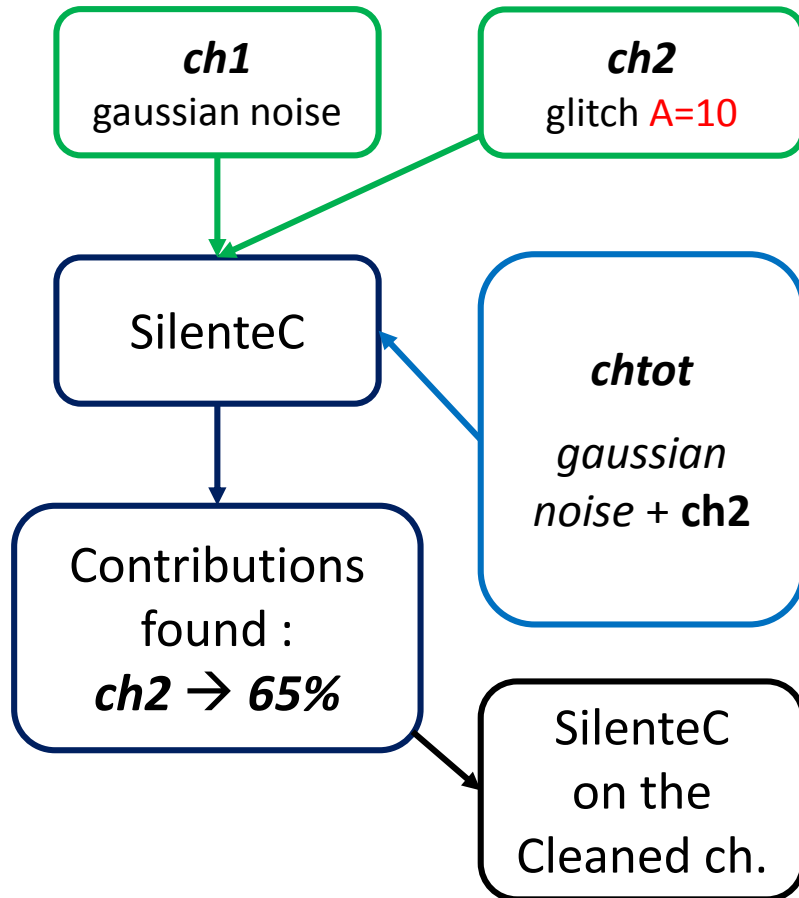

1112223337.0000 : Apr 4 2015 22:55:21 UTC

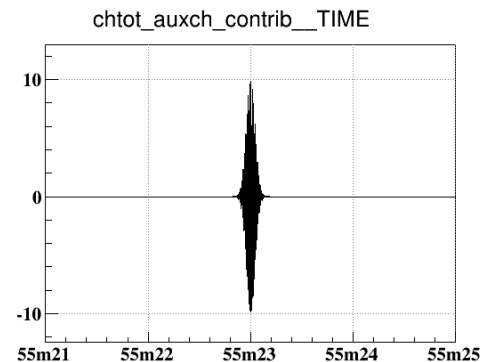

1112223337.0000 : Apr 4 2015 22:55:21 UTC

Contributions

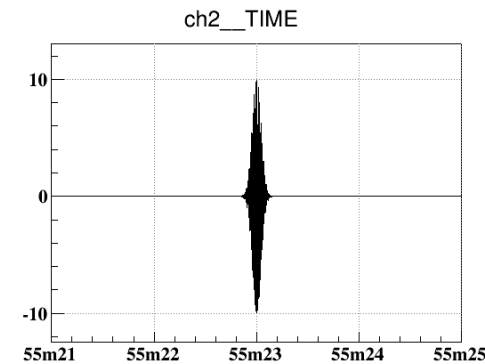

1112223337.0000 : Apr 4 2015 22:55:21 UTC

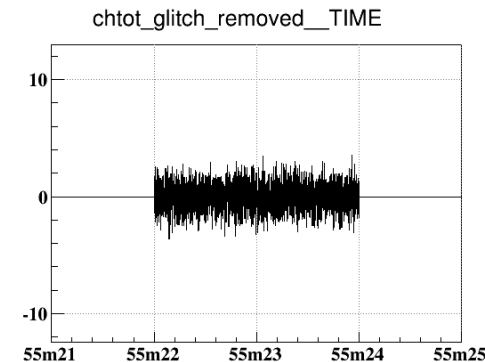

1112223337.0000 : Apr 4 2015 22:55:21 UTC

Cleaned channel
(Main ch. - Contrib.)

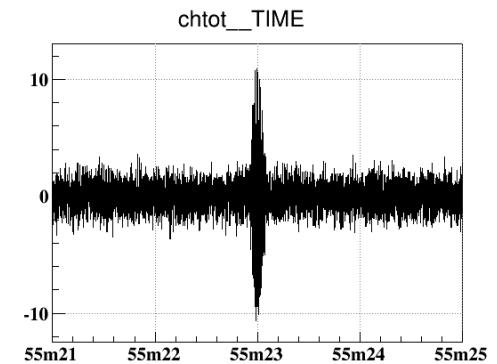

1112223337.0000 : Apr 4 2015 22:55:21 UTC

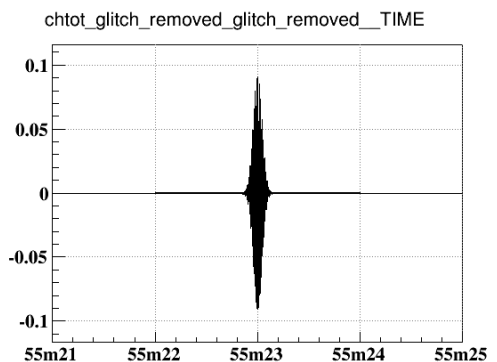

1112223337.0000 : Apr 4 2015 22:55:21 UTC

Residuals
(Cleaned ch. - gaussian noise)

glitch + gaussian noise

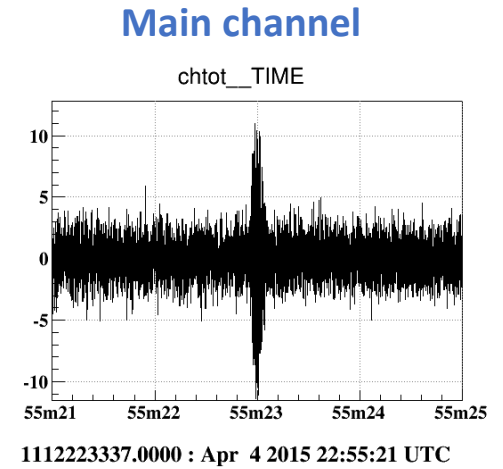
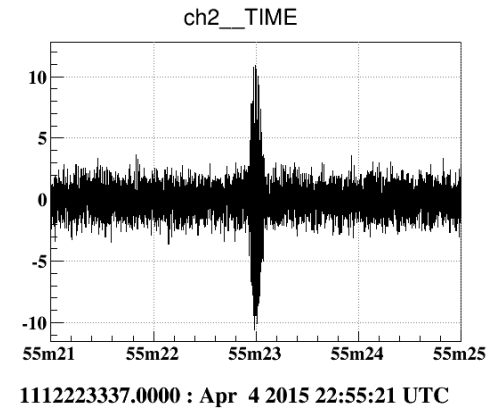
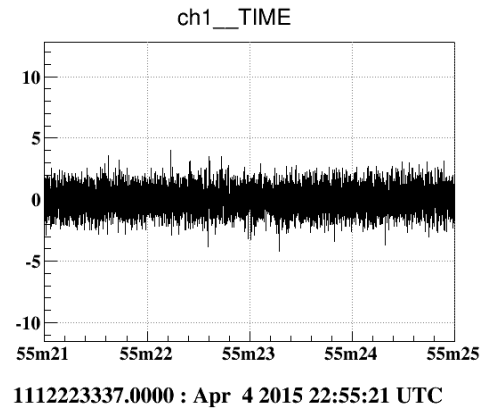
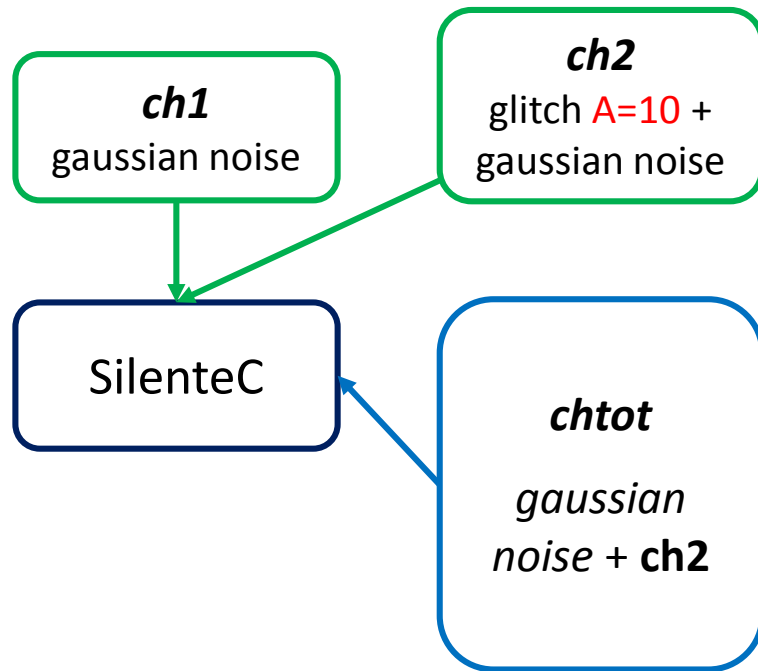

glitch + gaussian noise

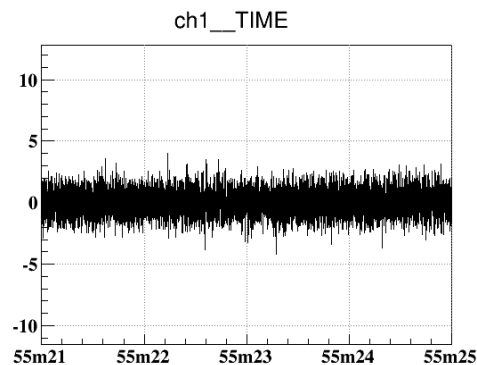
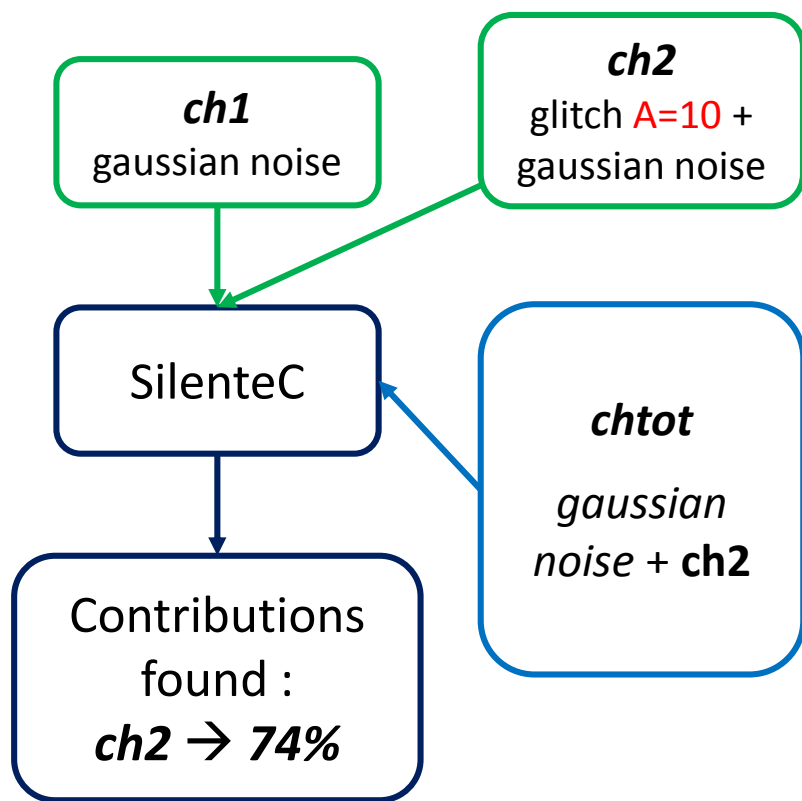

1112223337.0000 : Apr 4 2015 22:55:21 UTC

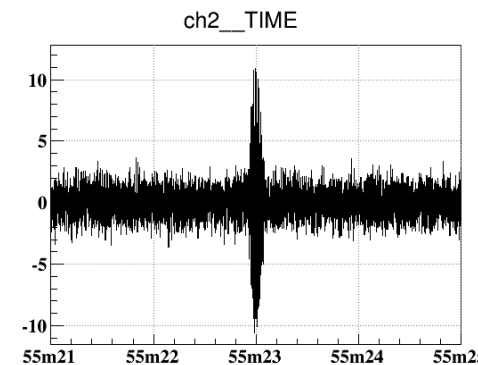

1112223337.0000 : Apr 4 2015 22:55:21 UTC

Main channel

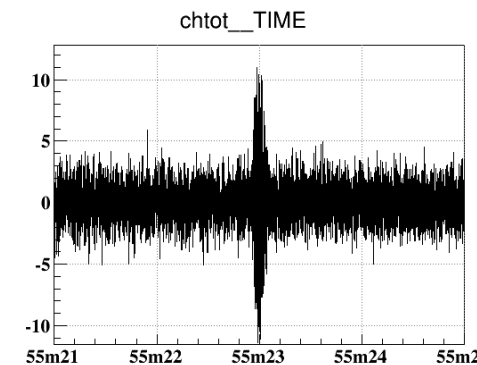

1112223337.0000 : Apr 4 2015 22:55:21 UTC

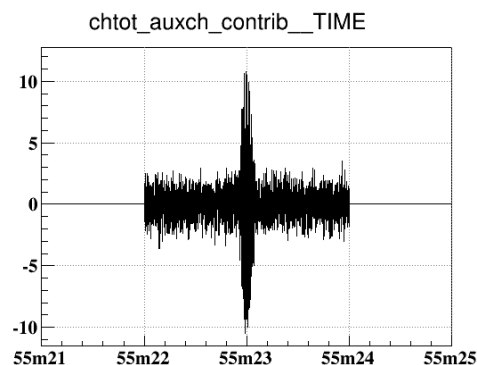

1112223337.0000 : Apr 4 2015 22:55:21 UTC

Contributions

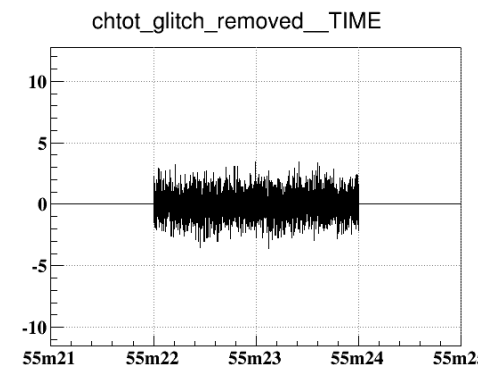

1112223337.0000 : Apr 4 2015 22:55:21 UTC

Cleaned channel
(Main ch. - Contrib.)

glitch + gaussian noise

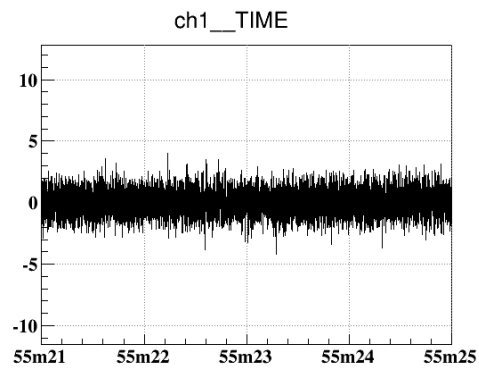
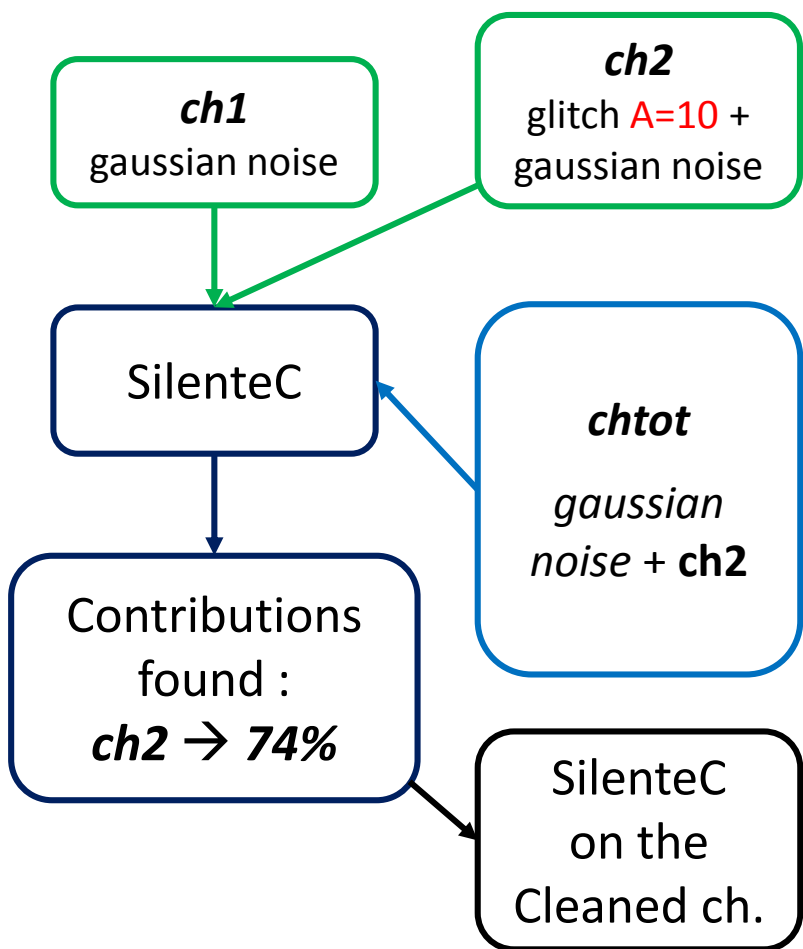

1112223337.0000 : Apr 4 2015 22:55:21 UTC

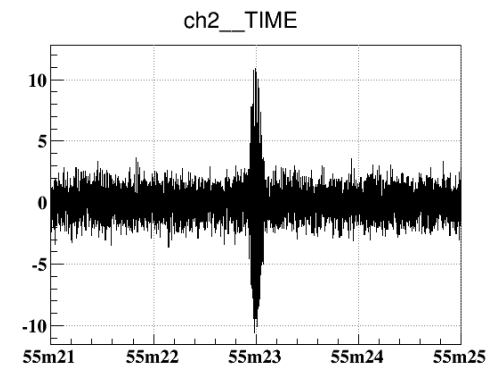

1112223337.0000 : Apr 4 2015 22:55:21 UTC

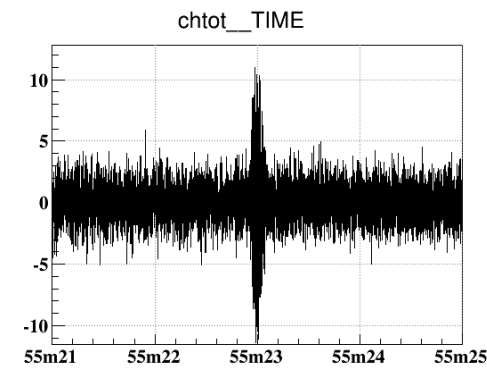

1112223337.0000 : Apr 4 2015 22:55:21 UTC

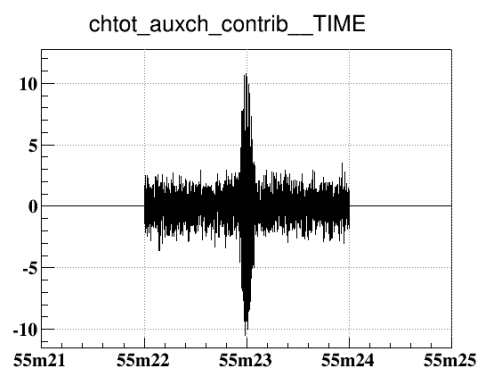

1112223337.0000 : Apr 4 2015 22:55:21 UTC

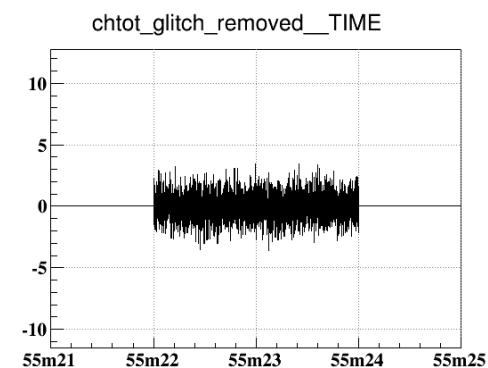

1112223337.0000 : Apr 4 2015 22:55:21 UTC

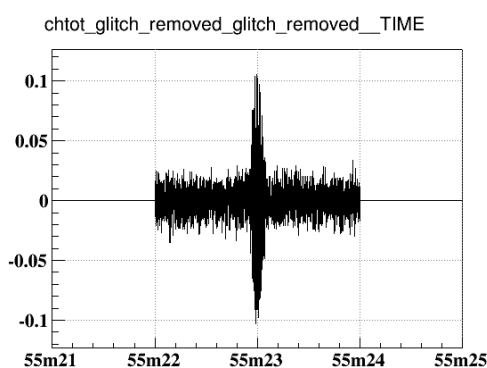

1112223337.0000 : Apr 4 2015 22:55:21 UTC

Contributions

Cleaned channel
(Main ch. - Contrib.)

Residuals
(Cleaned ch. - gaussian noise)

Main channel

product of channels: glitch + gaussian noise

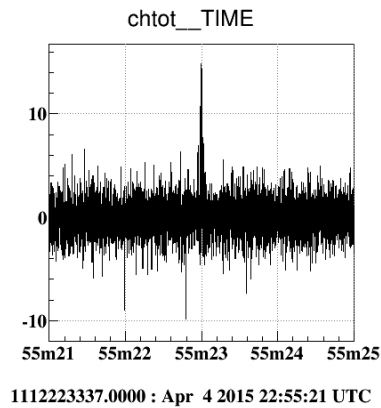
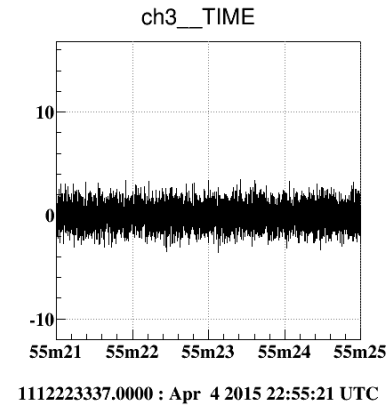
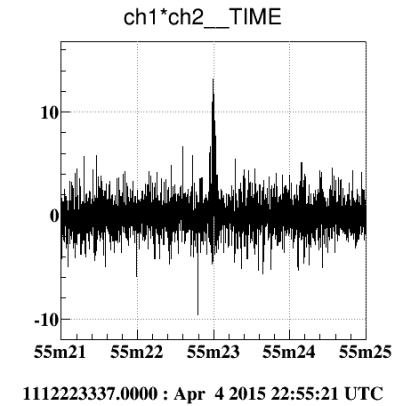
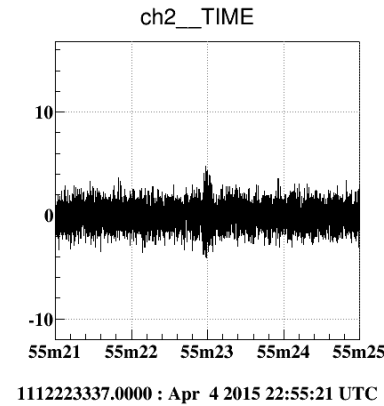
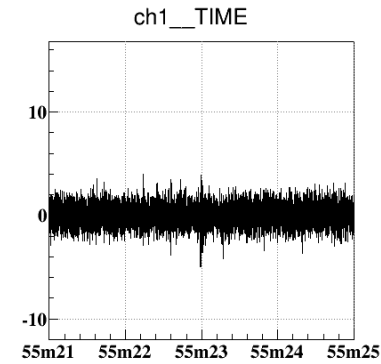
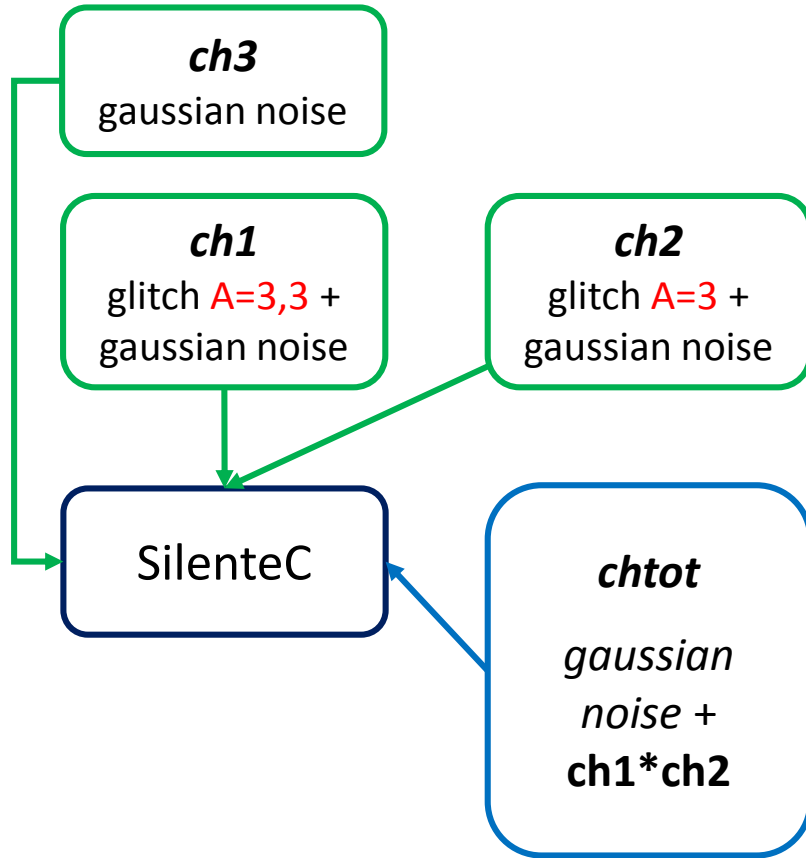

Main channel

product of channels: glitch + gaussian noise

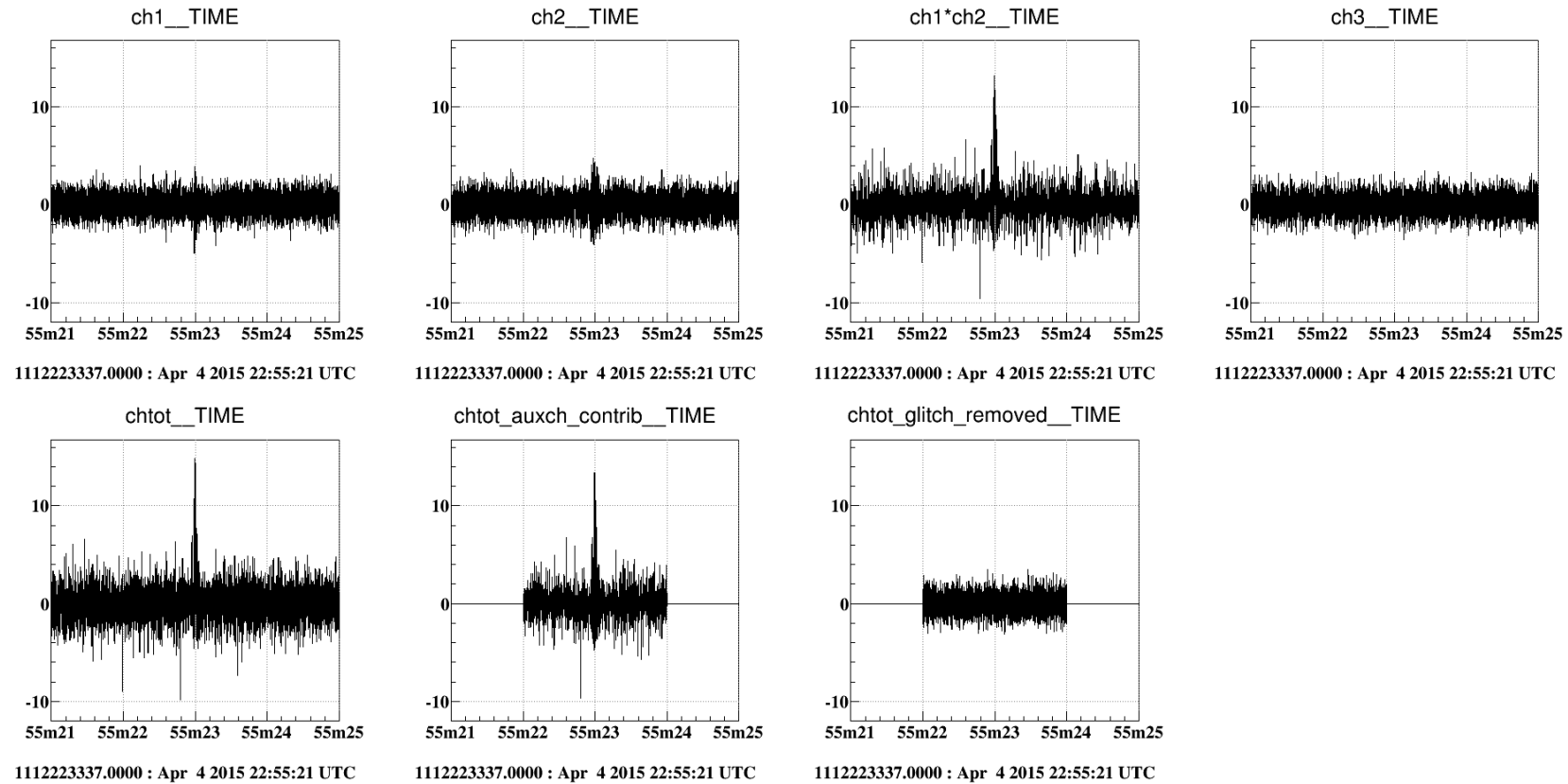
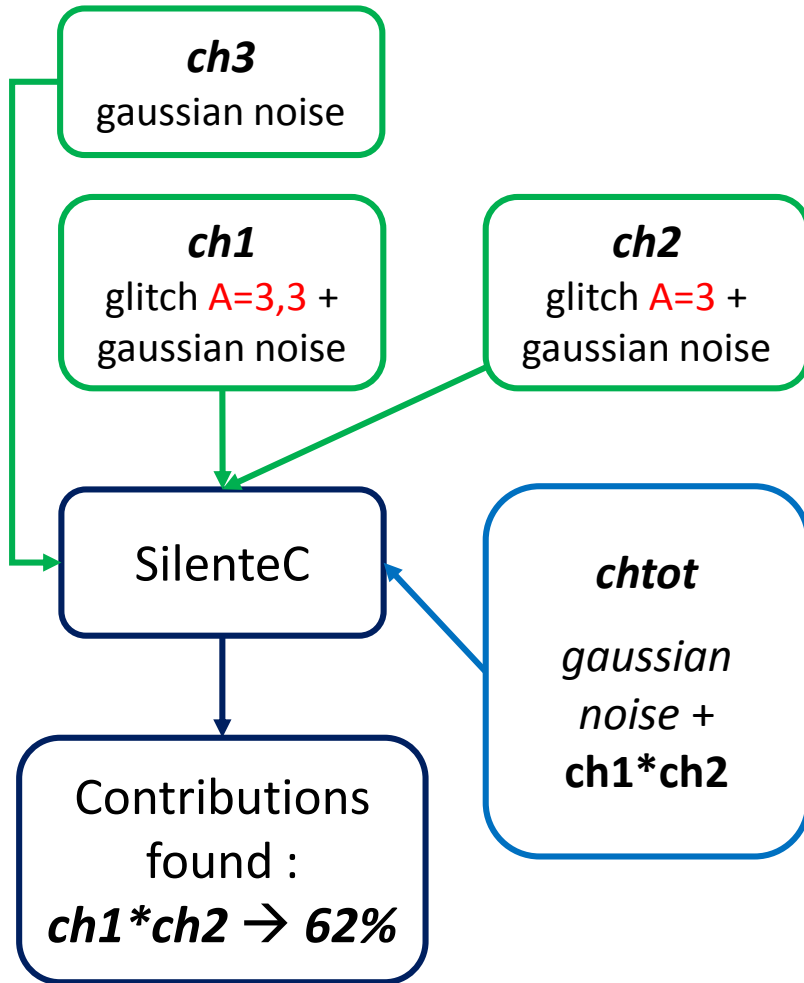

Main channel

Contributions

Cleaned channel
(Main ch. - Contrib.)

product of channels: glitch + gaussian noise

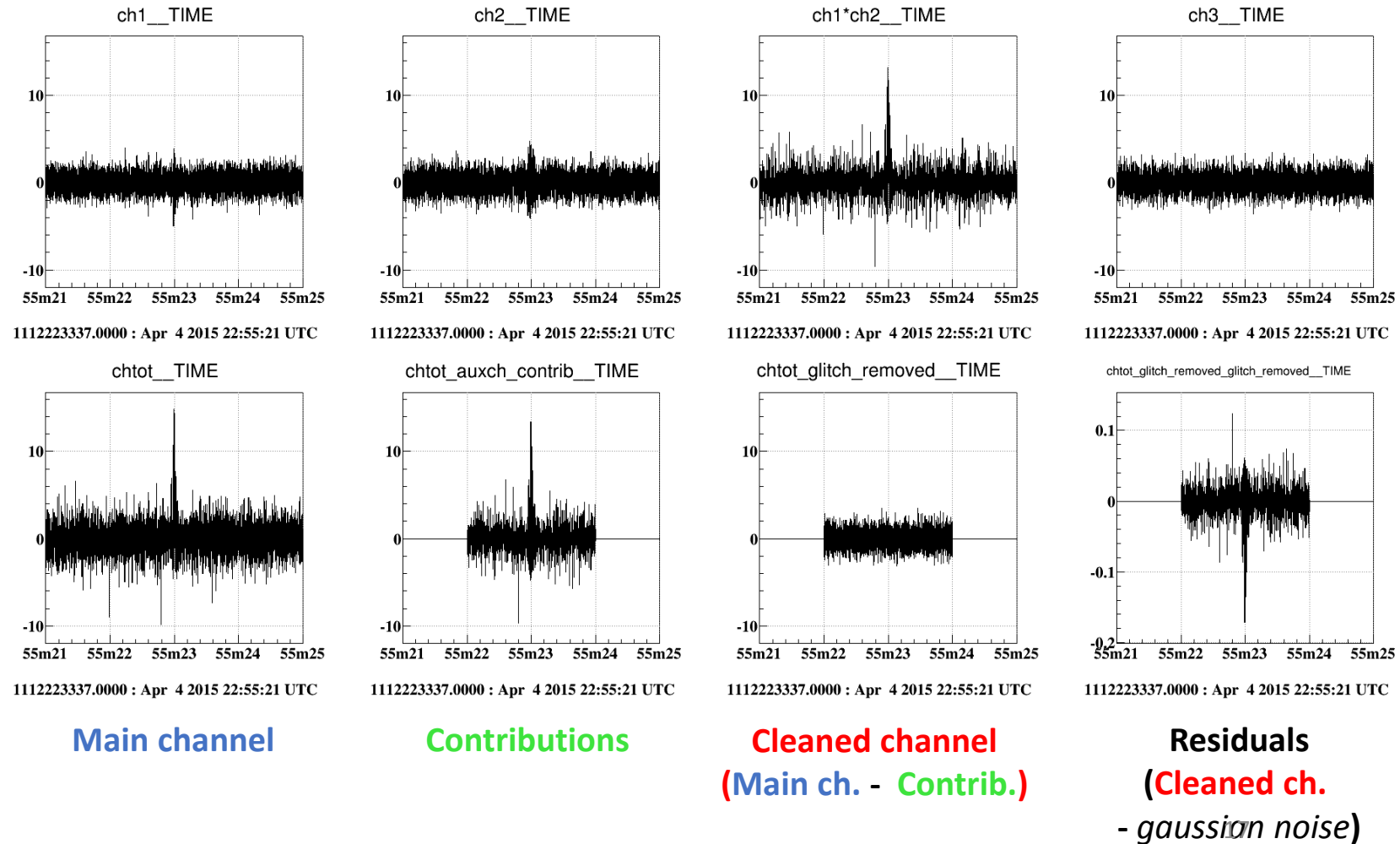
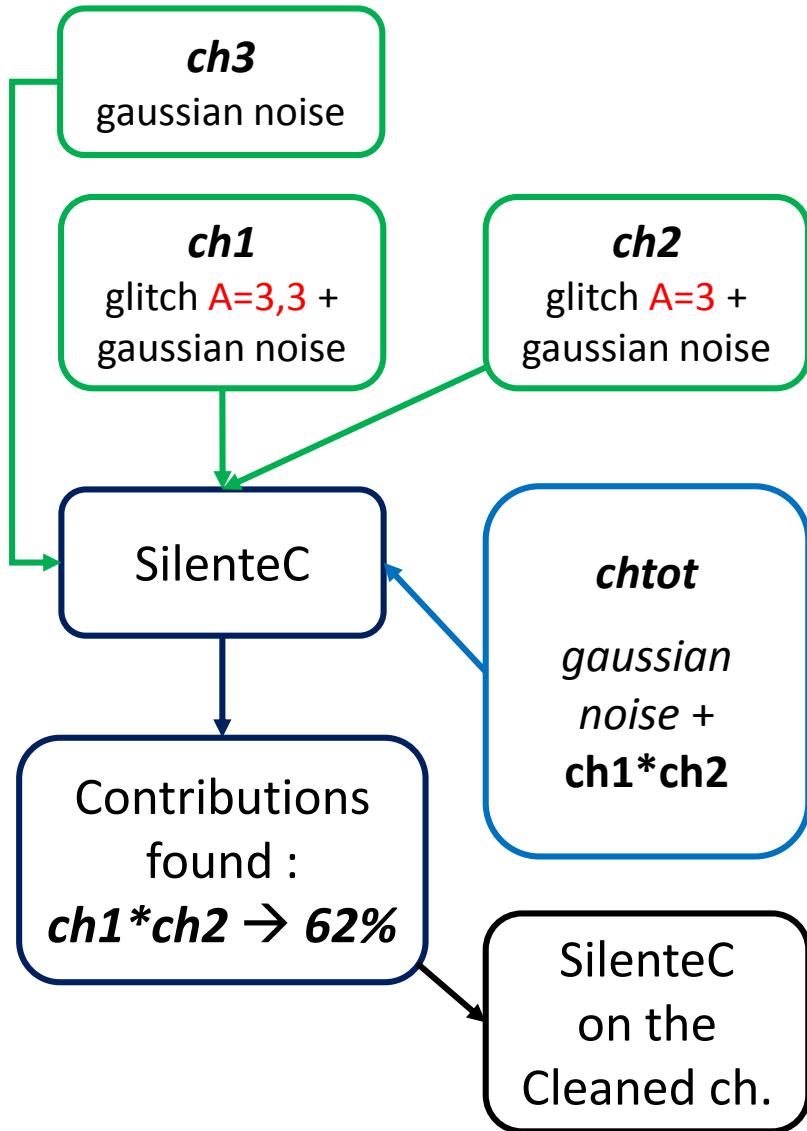

product of channels: loud glitch + gaussian noise

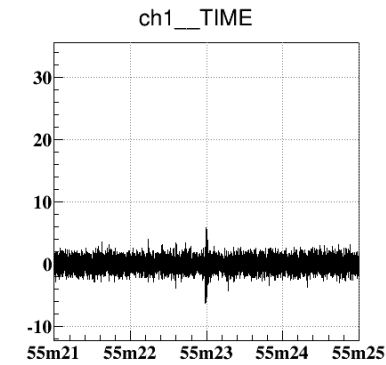
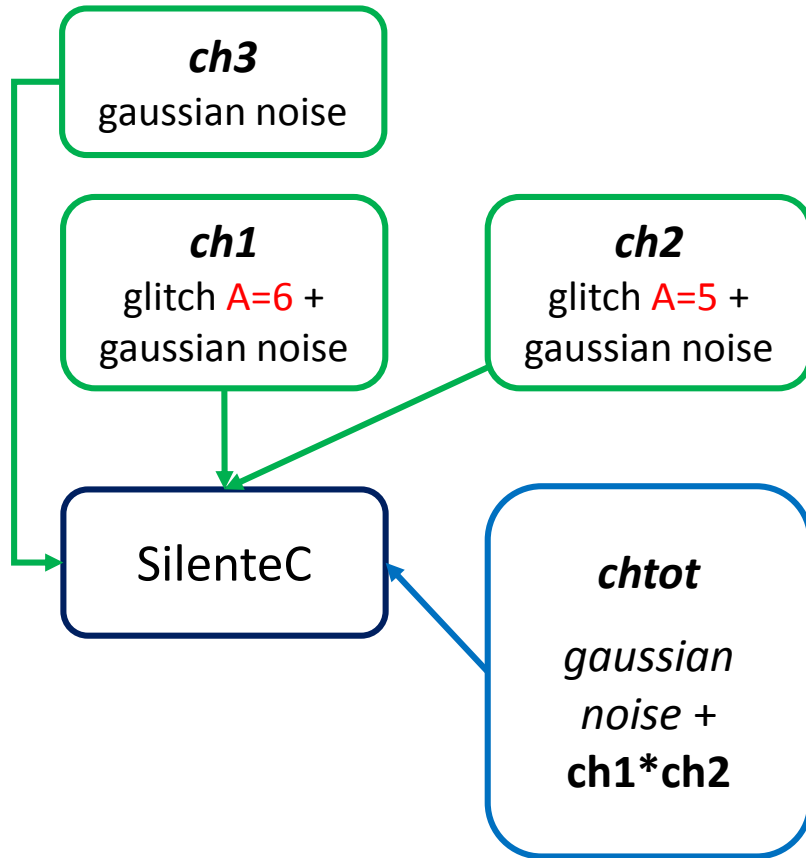

1112223337.0000 : Apr 4 2015 22:55:21 UTC

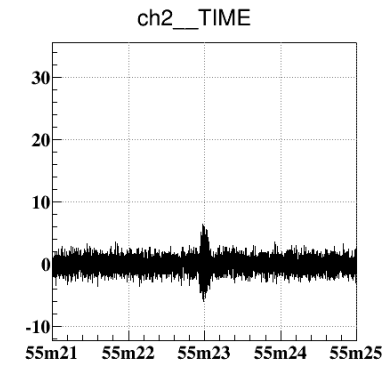

1112223337.0000 : Apr 4 2015 22:55:21 UTC

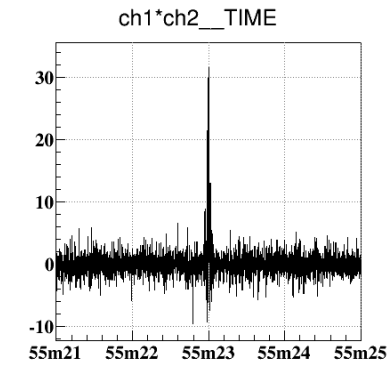

1112223337.0000 : Apr 4 2015 22:55:21 UTC

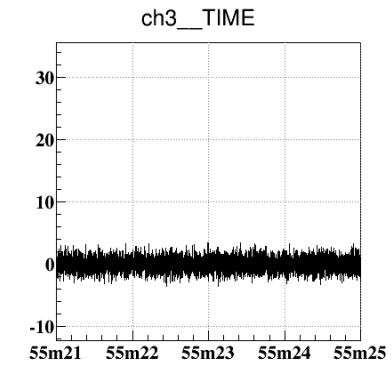

1112223337.0000 : Apr 4 2015 22:55:21 UTC

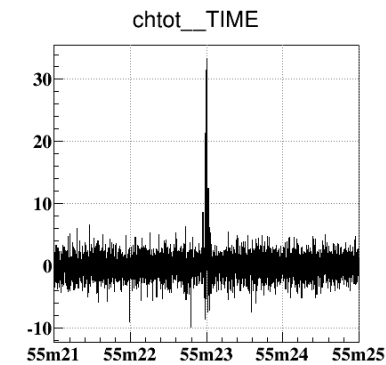

1112223337.0000 : Apr 4 2015 22:55:21 UTC

Main channel

product of channels: loud glitch + gaussian noise

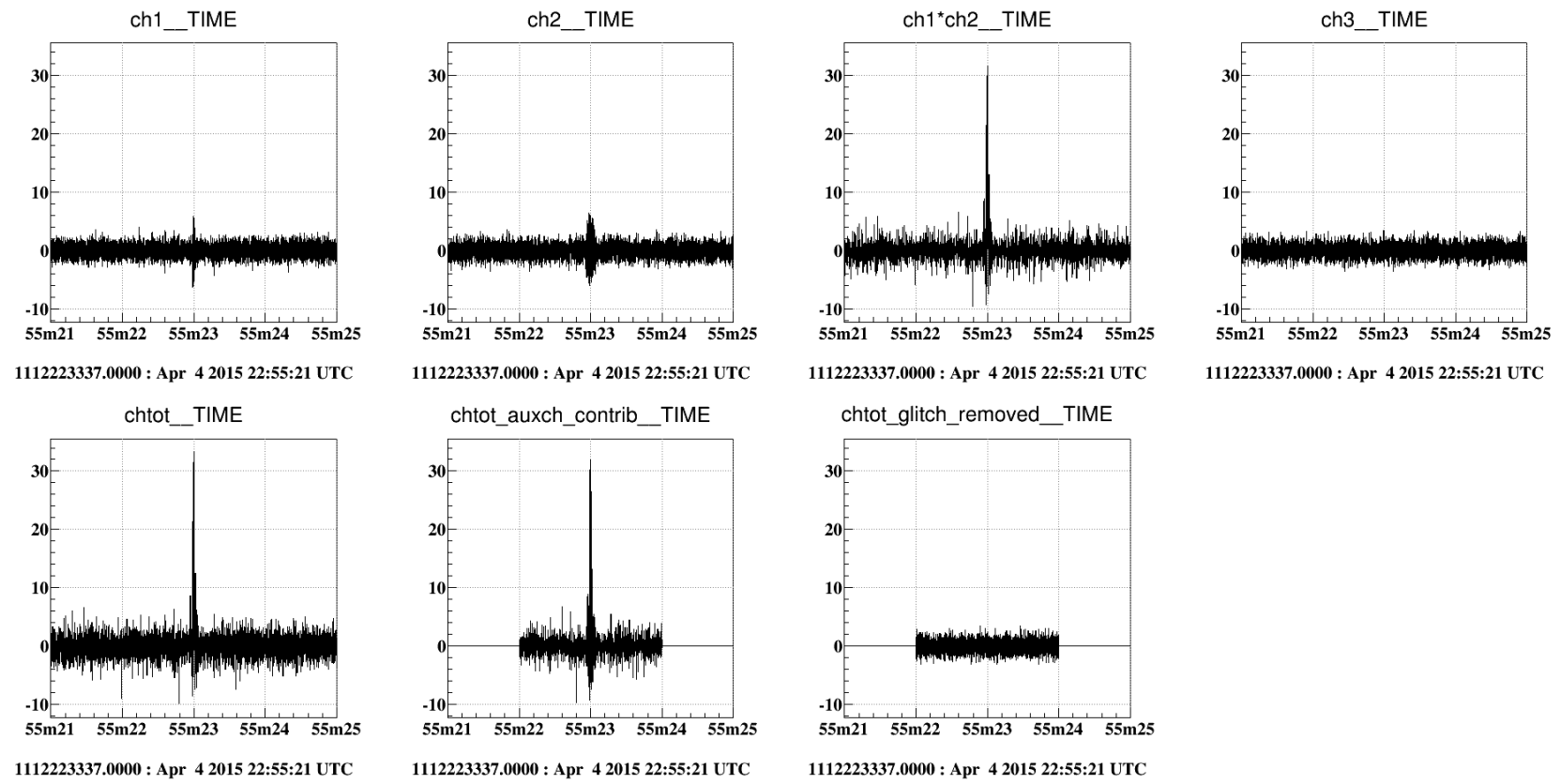
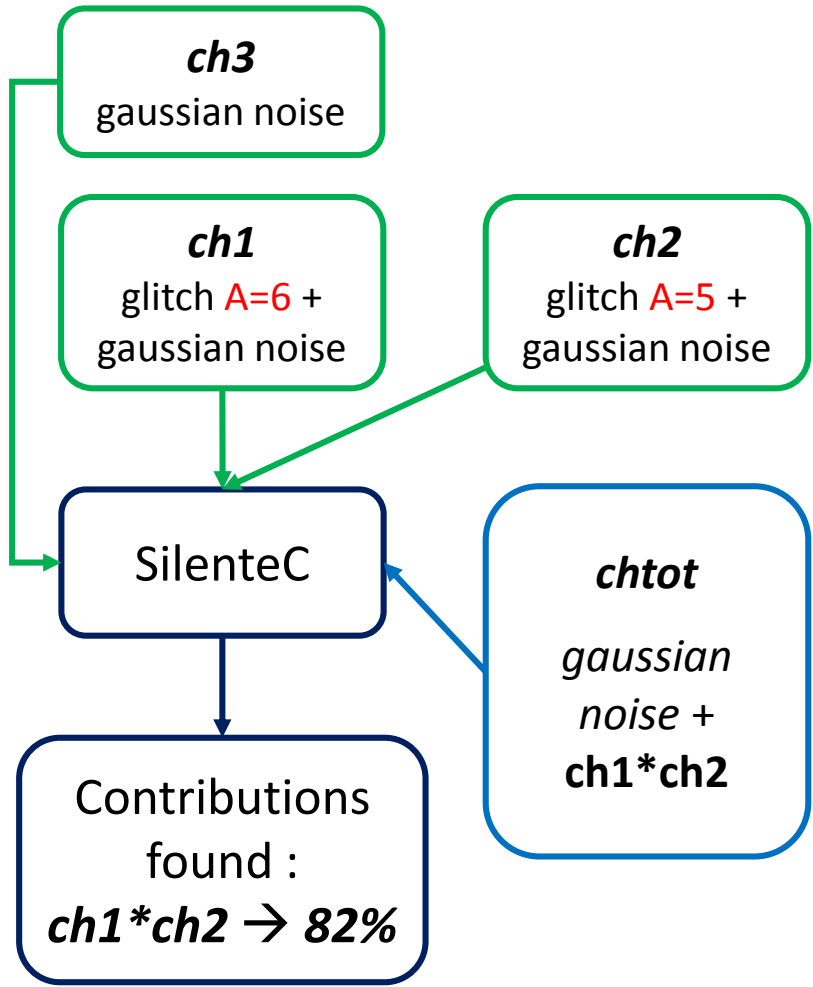

Main channel

Contributions

Cleaned channel
(Main ch. - Contrib.)

product of channels: loud glitch + gaussian noise

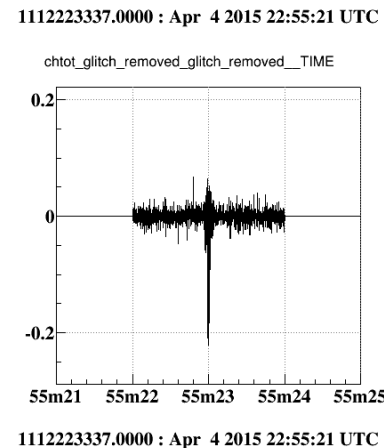
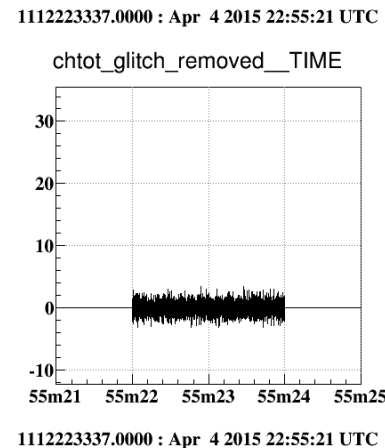
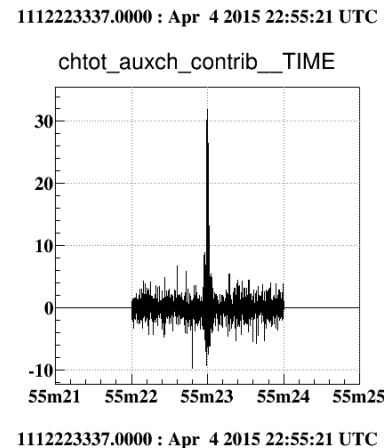
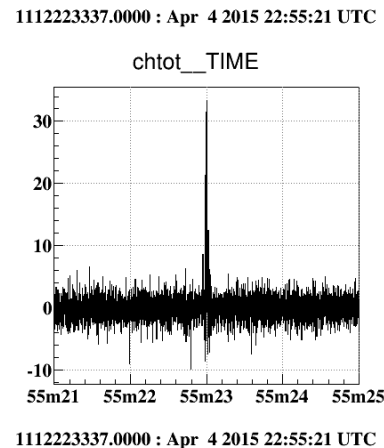
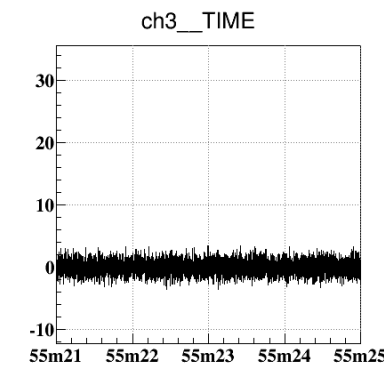
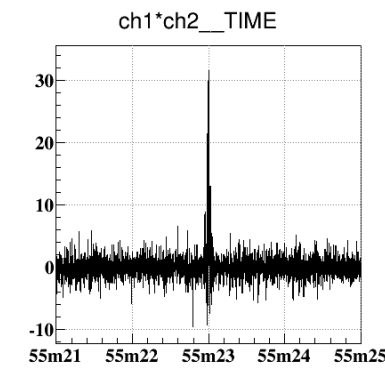
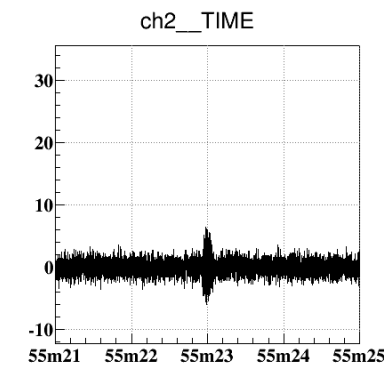
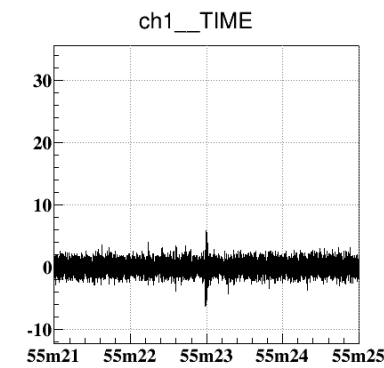
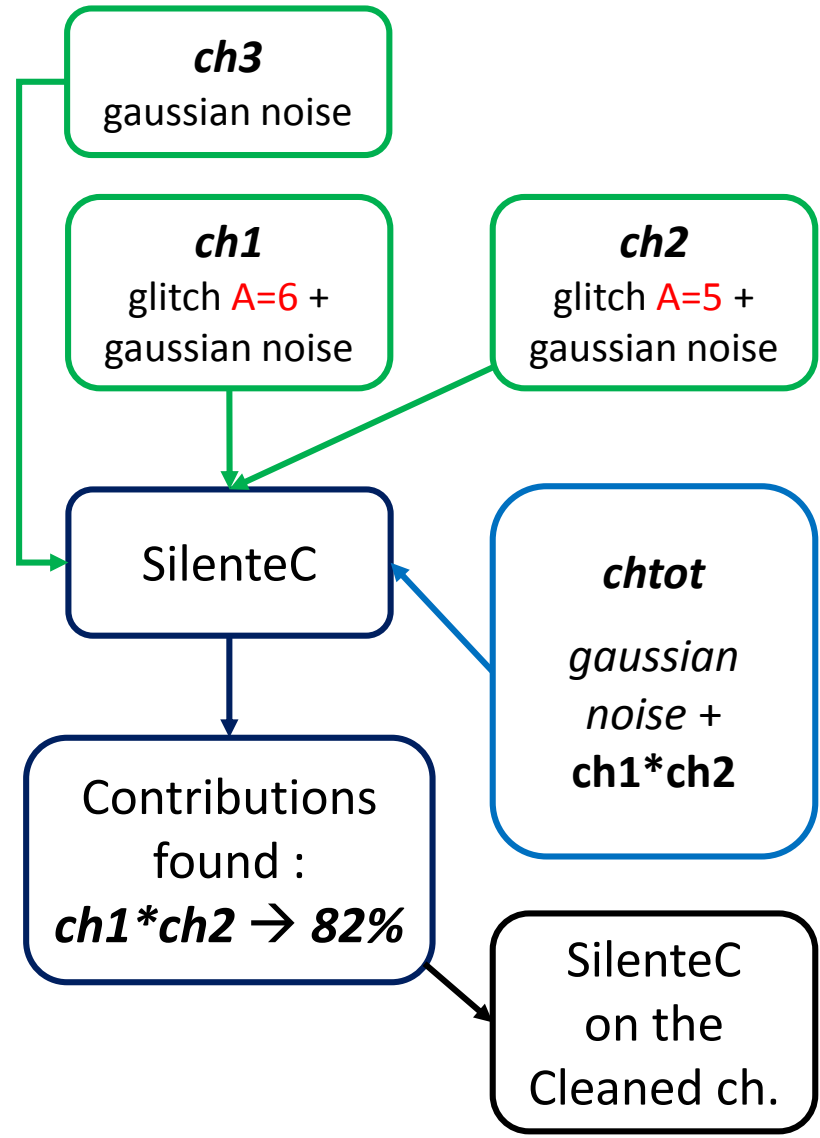

Main channel

Contributions

Cleaned channel
(Main ch. - Contrib.)

Residuals
(Cleaned ch.
- gaussian noise)

glitch & line

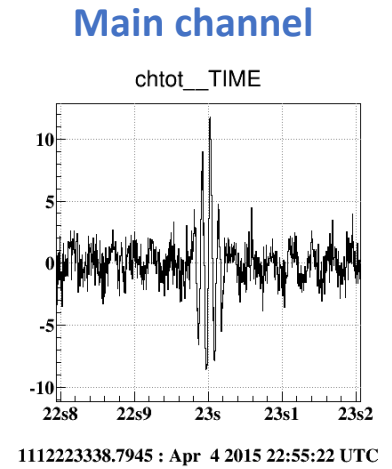
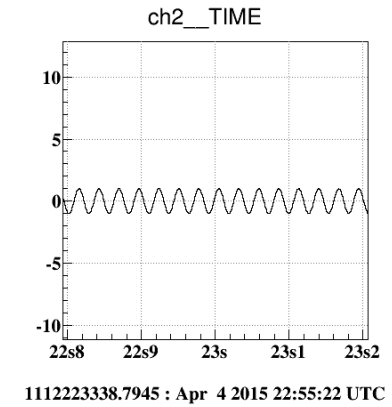
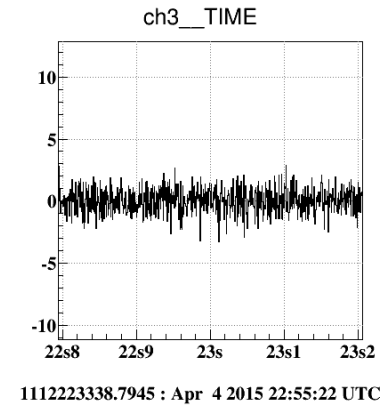
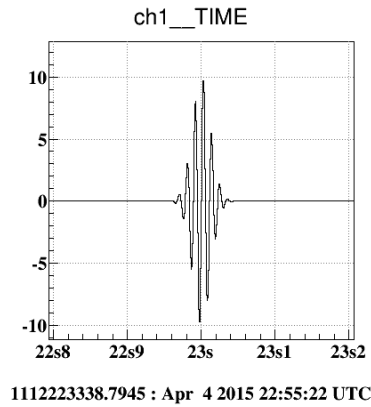
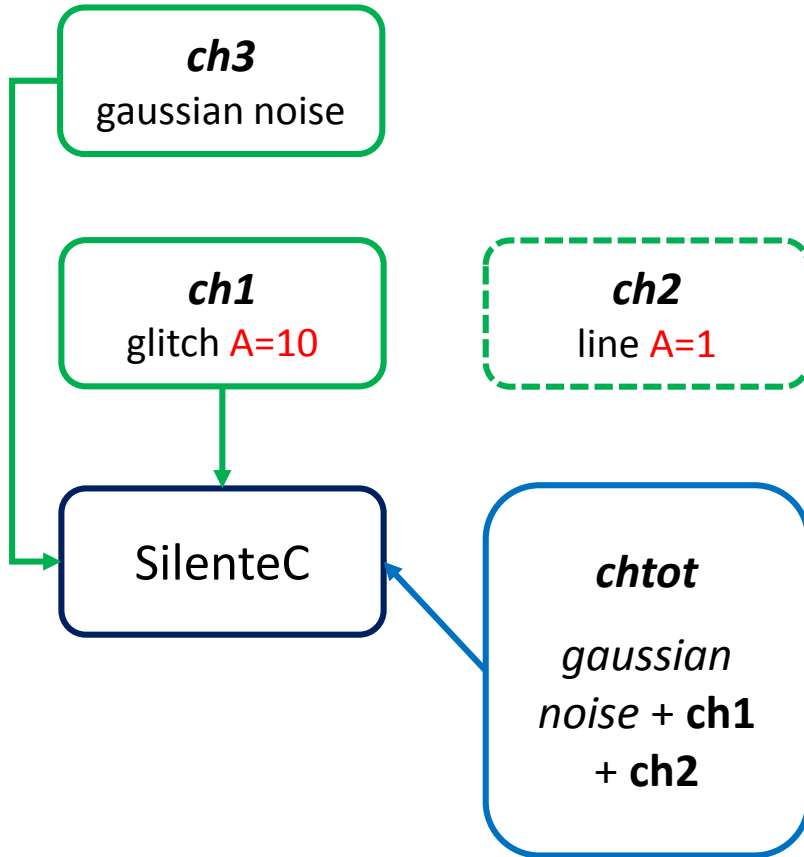

glitch & line

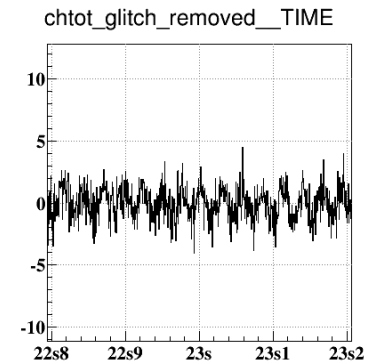
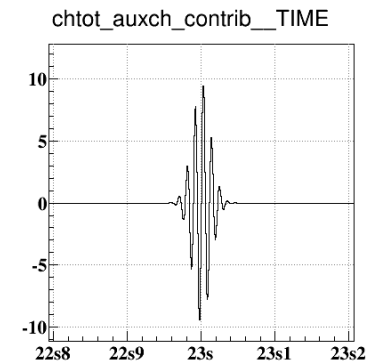
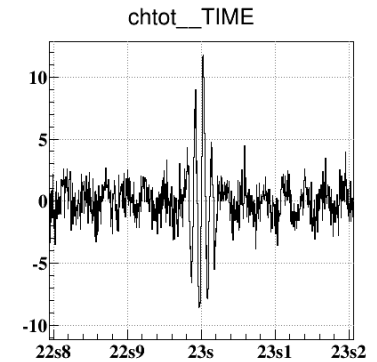
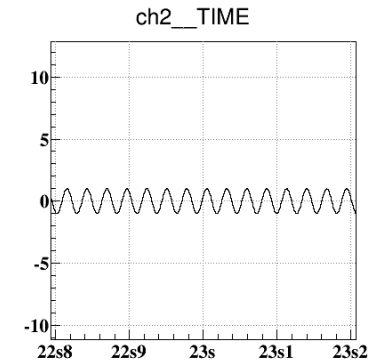
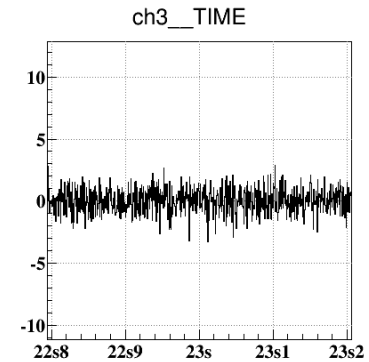
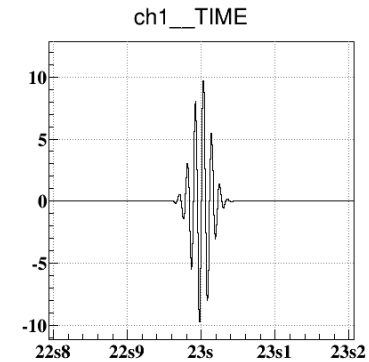
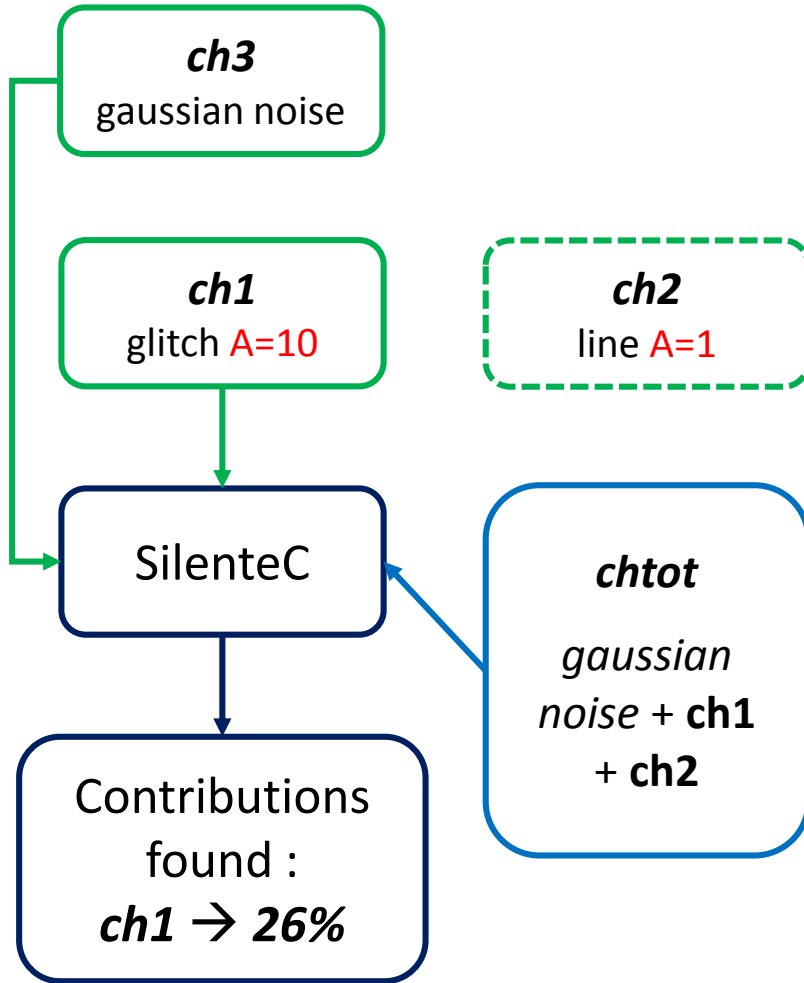

Contributions

Cleaned channel
(Main ch. - Contrib.)

Main channel

glitch & line

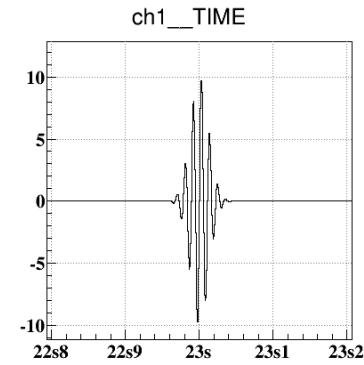
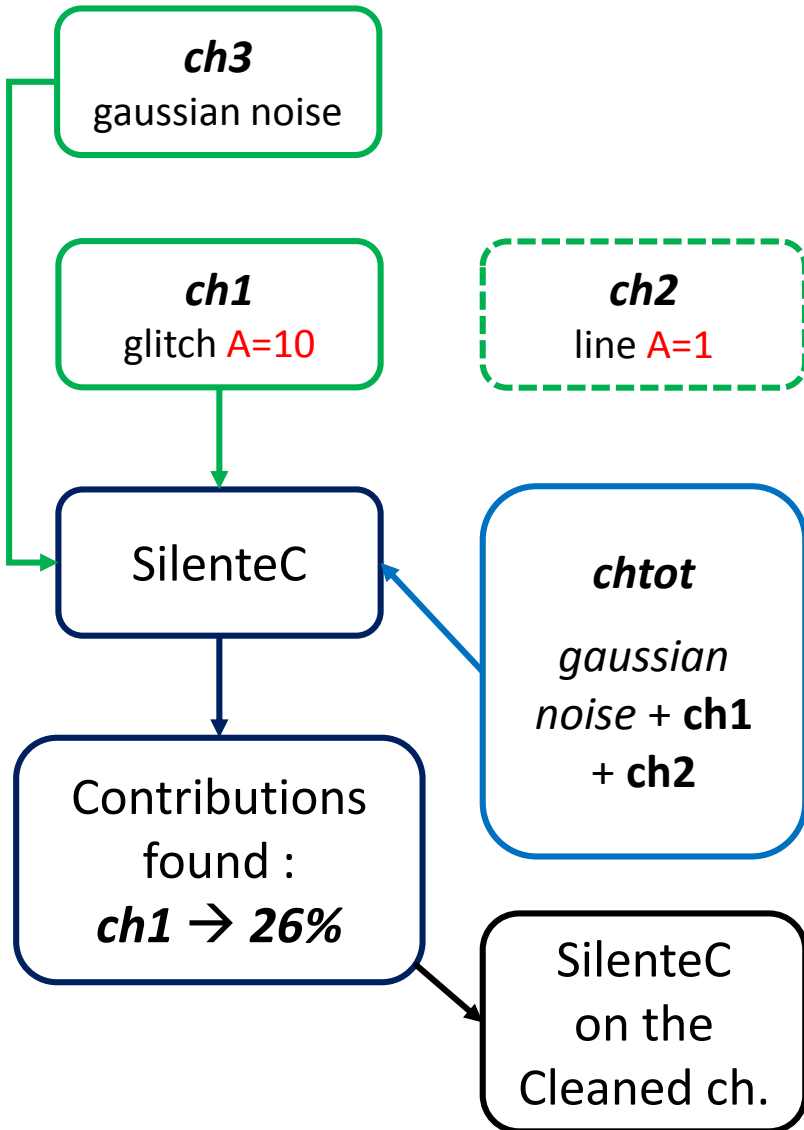

1112223338.7945 : Apr 4 2015 22:55:22 UTC

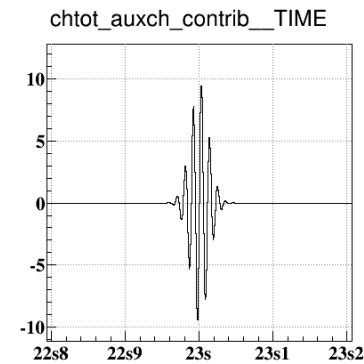

1112223338.7945 : Apr 4 2015 22:55:22 UTC

Contributions

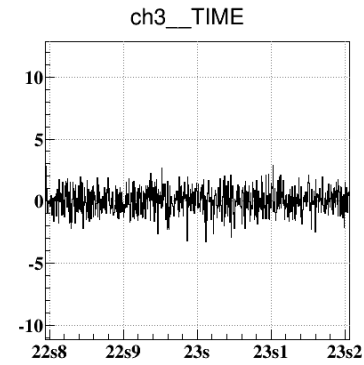

1112223338.7945 : Apr 4 2015 22:55:22 UTC

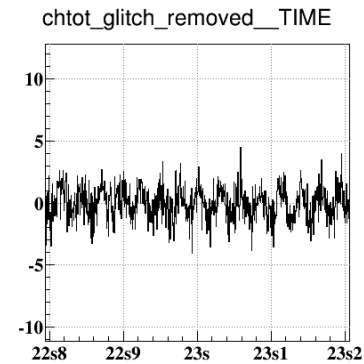

1112223338.7945 : Apr 4 2015 22:55:22 UTC

Cleaned channel
(Main ch. - Contrib.)

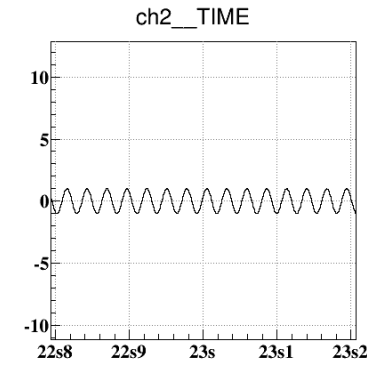

1112223338.7945 : Apr 4 2015 22:55:22 UTC

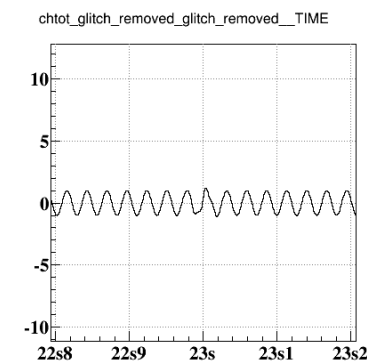

1112223338.7945 : Apr 4 2015 22:55:22 UTC

Residuals
(Cleaned ch.
- gaussian noise)

Main channel

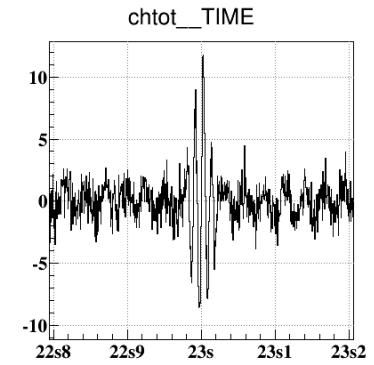

1112223338.7945 : Apr 4 2015 22:55:22 UTC

glitch & line

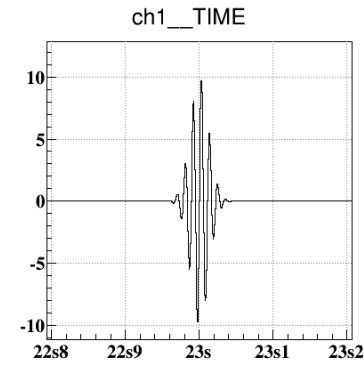
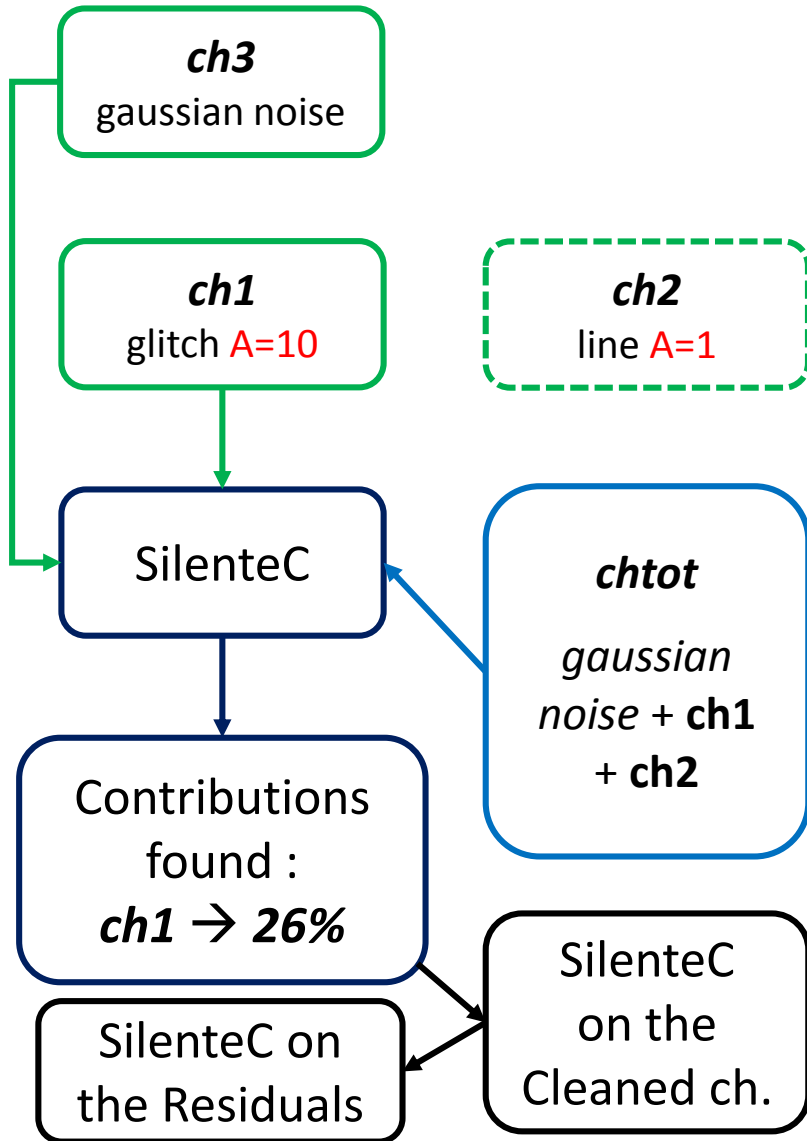

1112223338.7945 : Apr 4 2015 22:55:22 UTC

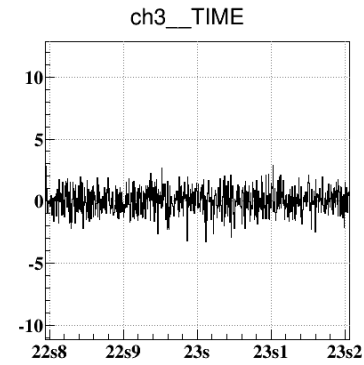

1112223338.7945 : Apr 4 2015 22:55:22 UTC

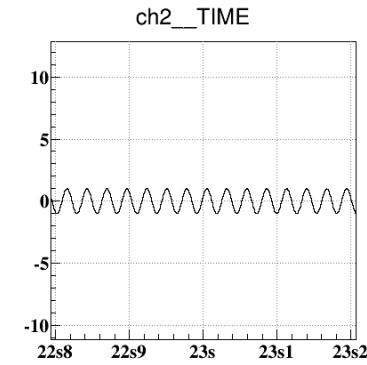

1112223338.7945 : Apr 4 2015 22:55:22 UTC

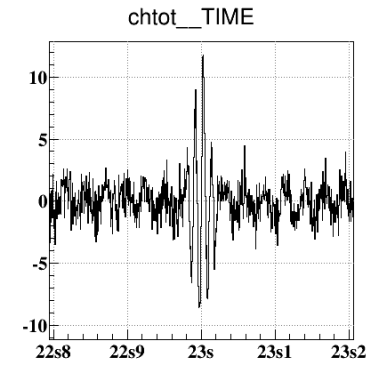

1112223338.7945 : Apr 4 2015 22:55:22 UTC

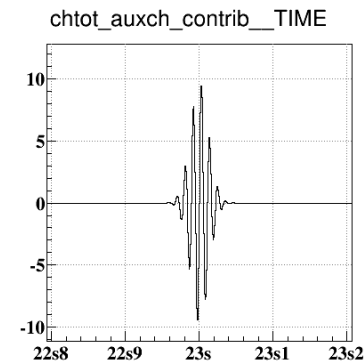

1112223338.7945 : Apr 4 2015 22:55:22 UTC

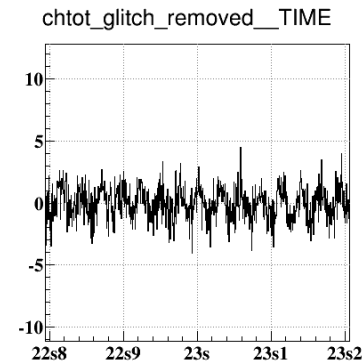

1112223338.7945 : Apr 4 2015 22:55:22 UTC

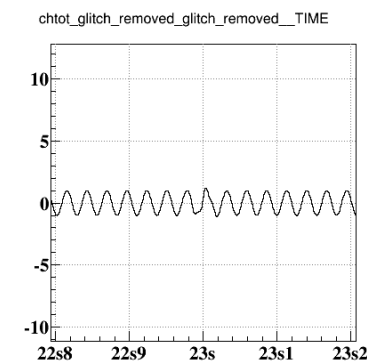

1112223338.7945 : Apr 4 2015 22:55:22 UTC

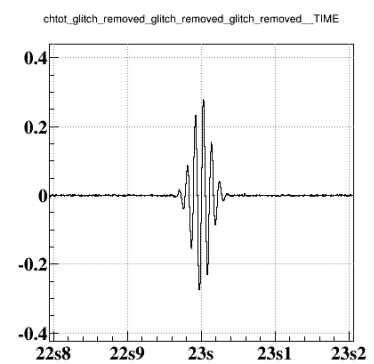

1112223338.7945 : Apr 4 2015 22:55:22 UTC

Contributions

Cleaned channel
(Main ch. - Contrib.)

Residuals
(Cleaned ch.
- gaussian noise)

After Residuals
(Residuals - line)

glitch + gaussian noise & line

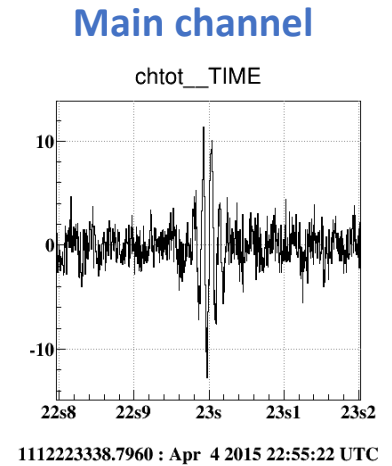
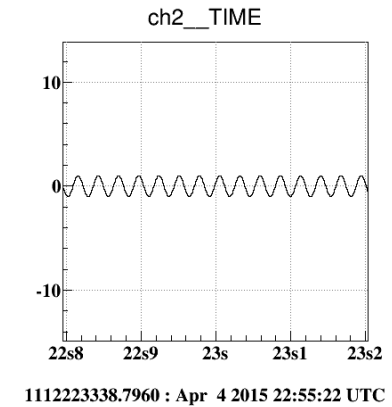
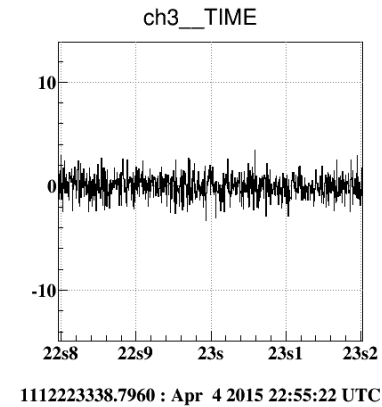
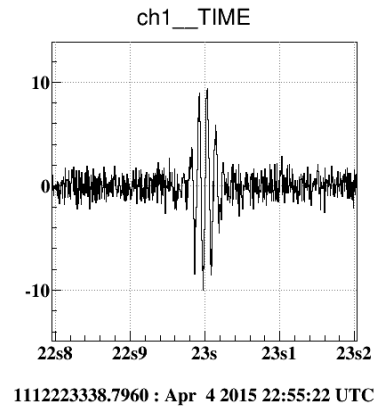
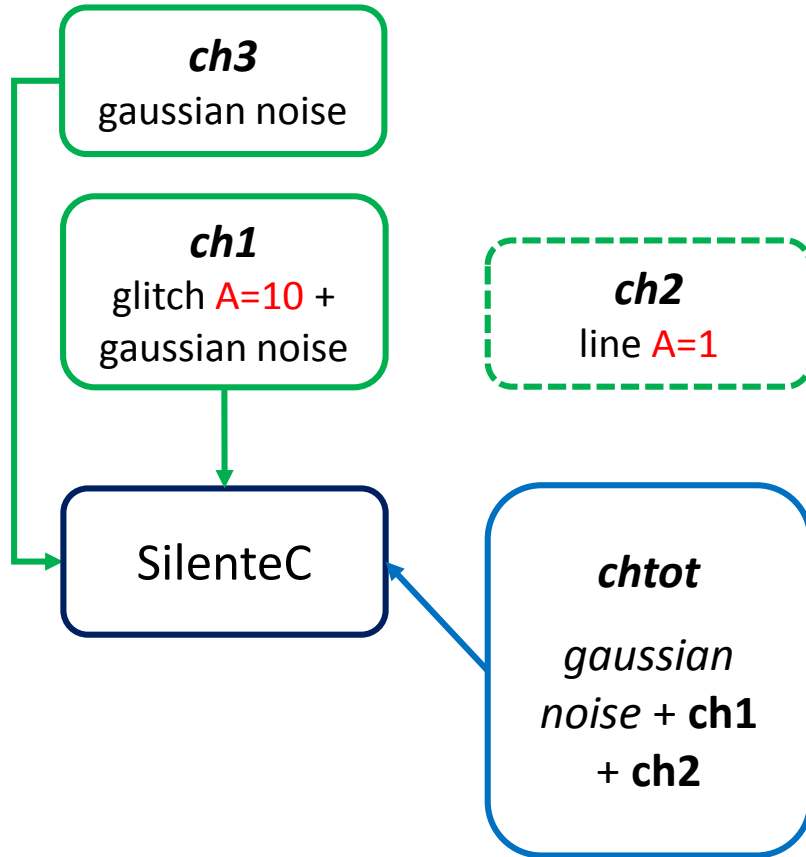

glitch + gaussian noise & line

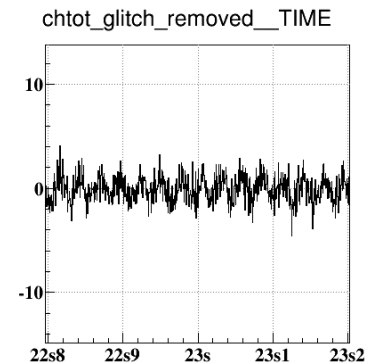
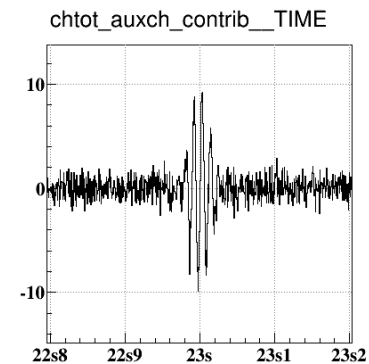
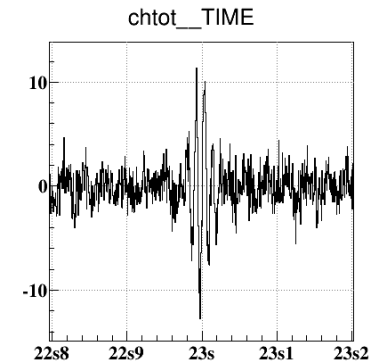
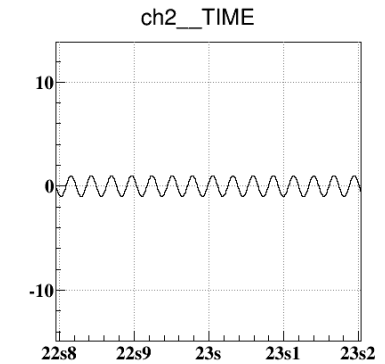
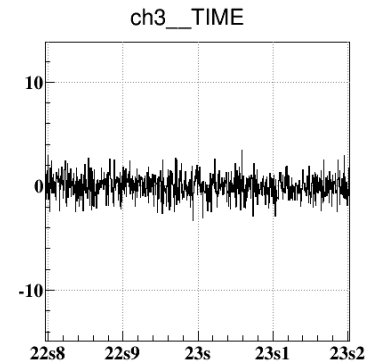
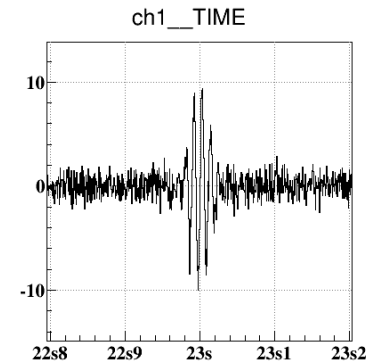
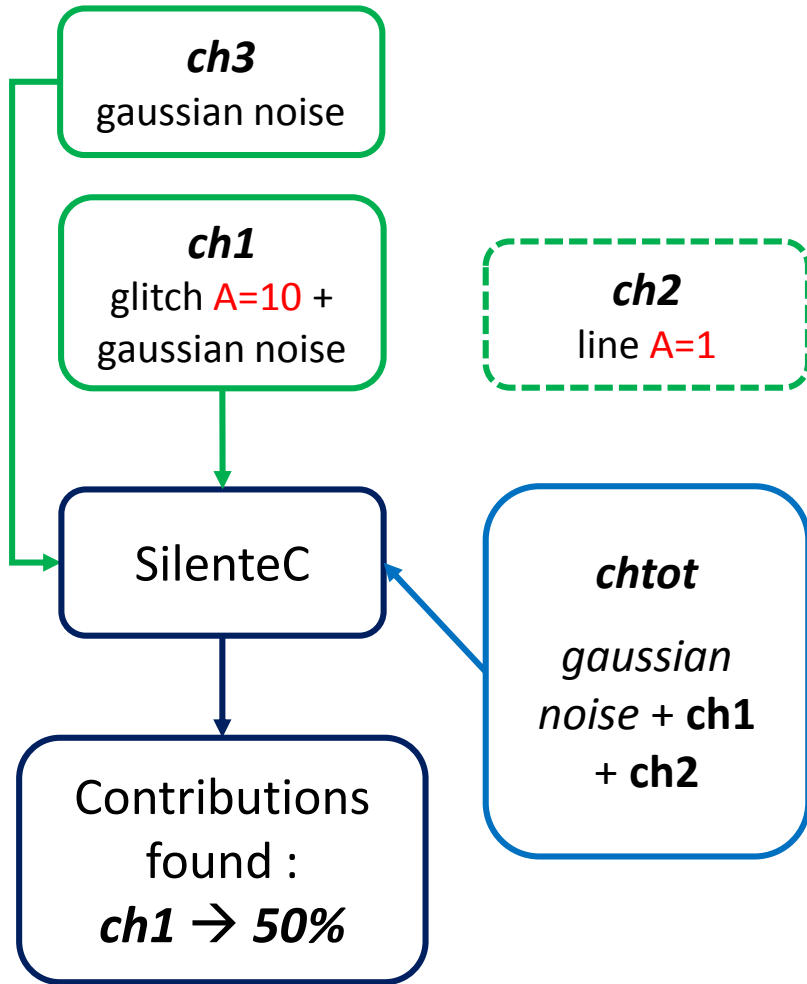

Contributions

Cleaned channel
(Main ch. - Contrib.)

Main channel

glitch + gaussian noise & line

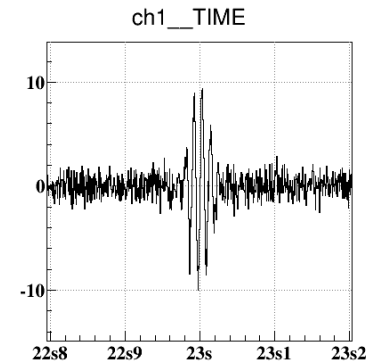
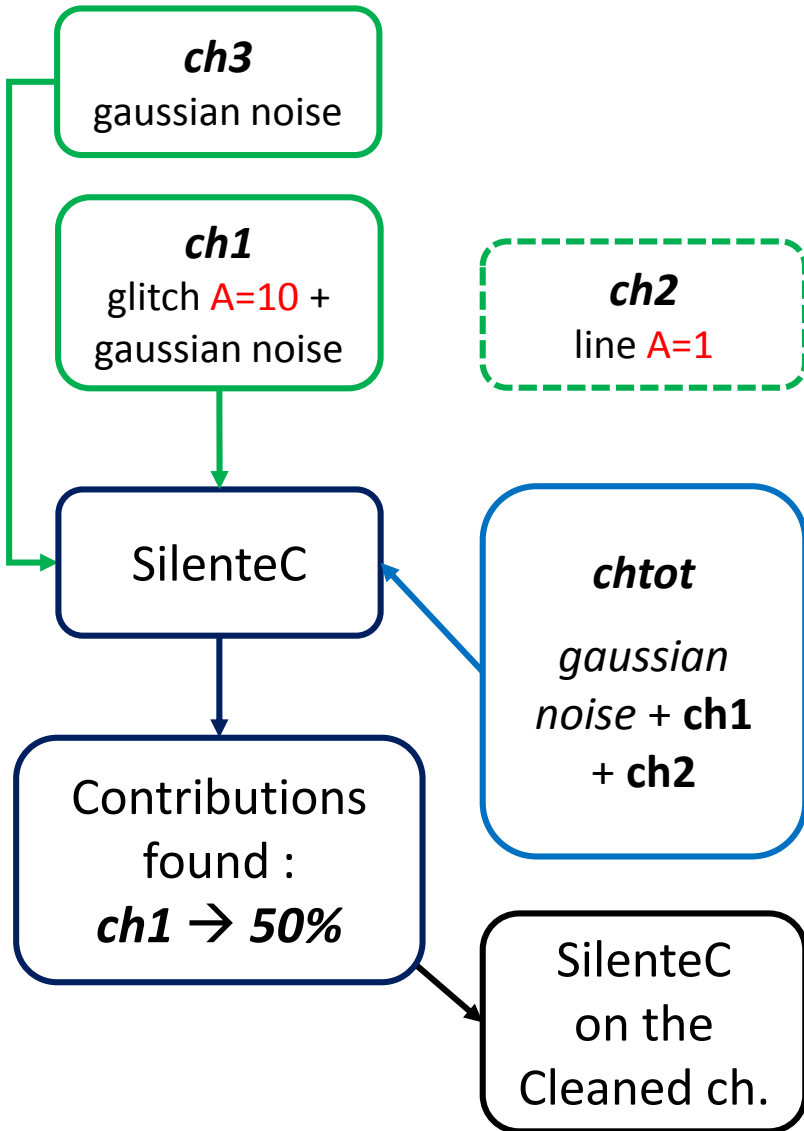

1112223338.7960 : Apr 4 2015 22:55:22 UTC

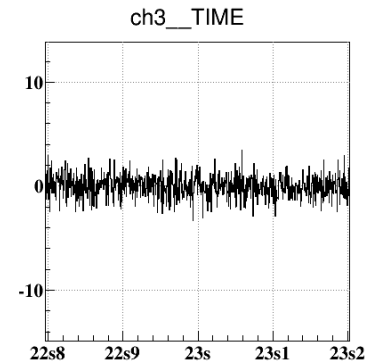

1112223338.7960 : Apr 4 2015 22:55:22 UTC

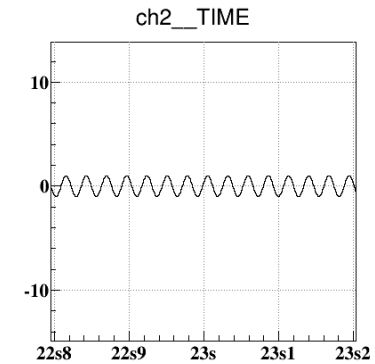

1112223338.7960 : Apr 4 2015 22:55:22 UTC

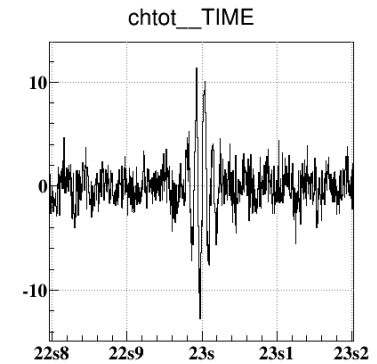

1112223338.7960 : Apr 4 2015 22:55:22 UTC

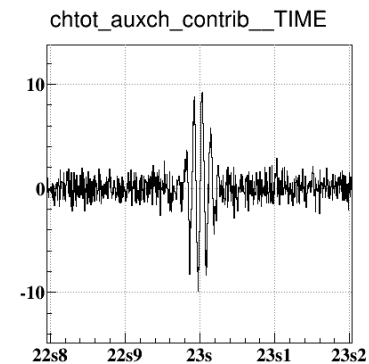

1112223338.7960 : Apr 4 2015 22:55:22 UTC

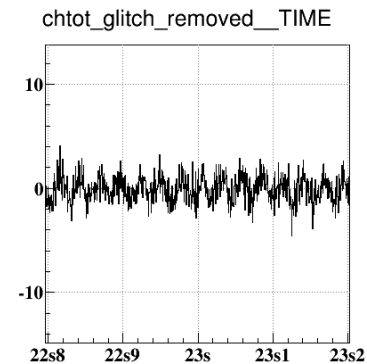

1112223338.7960 : Apr 4 2015 22:55:22 UTC

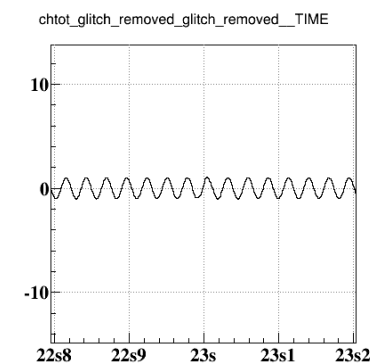

1112223338.7960 : Apr 4 2015 22:55:22 UTC

Contributions

Cleaned channel
(Main ch. - Contrib.)

Residuals
(Cleaned ch.
- gaussian noise)

glitch + gaussian noise & line

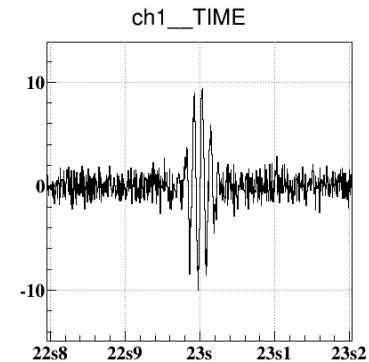
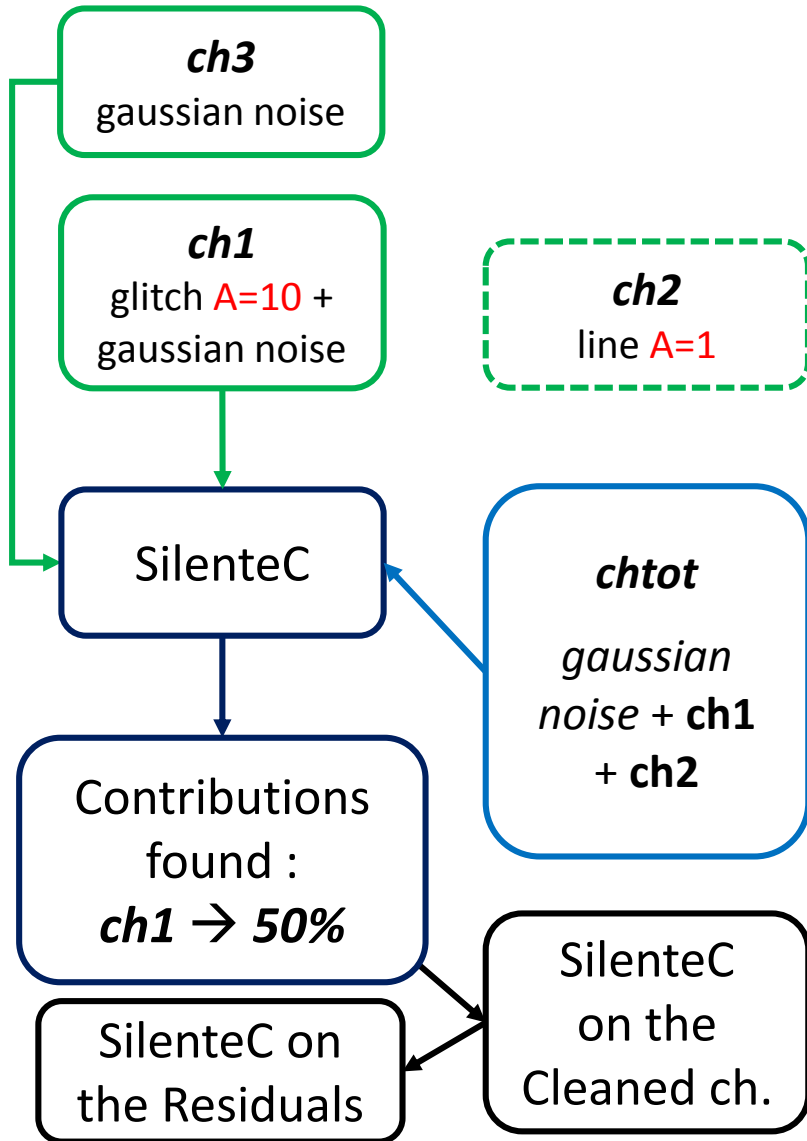

1112223338.7960 : Apr 4 2015 22:55:22 UTC

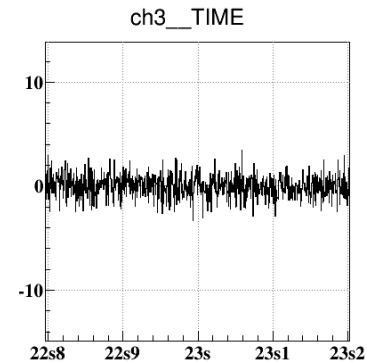

1112223338.7960 : Apr 4 2015 22:55:22 UTC

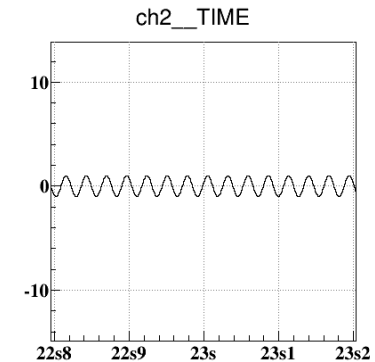

1112223338.7960 : Apr 4 2015 22:55:22 UTC

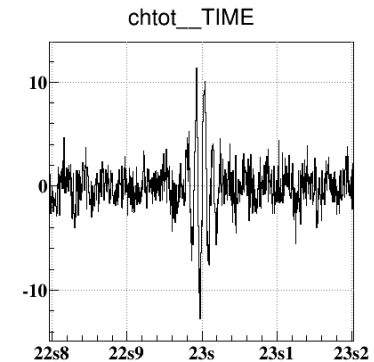

1112223338.7960 : Apr 4 2015 22:55:22 UTC

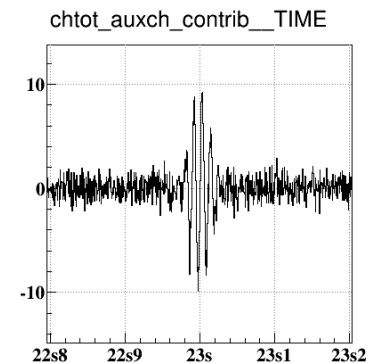

1112223338.7960 : Apr 4 2015 22:55:22 UTC

Contributions

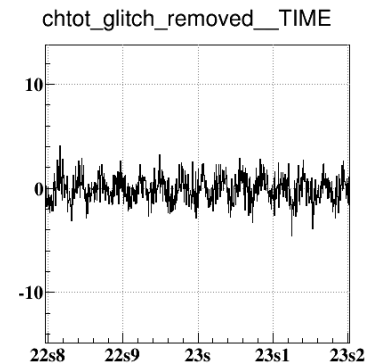

1112223338.7960 : Apr 4 2015 22:55:22 UTC

Cleaned channel
(Main ch. - Contrib.)

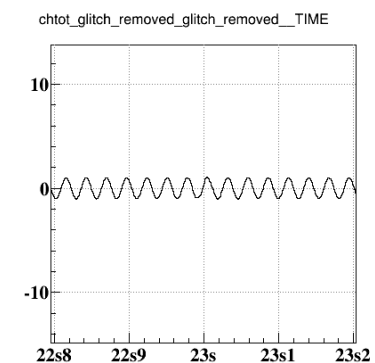

1112223338.7960 : Apr 4 2015 22:55:22 UTC

Residuals
(Cleaned ch.
- gaussian noise)

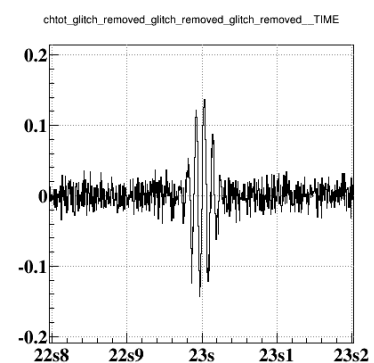

1112223338.7960 : Apr 4 2015 22:55:22 UTC

After Residuals
(Residuals - line)

glitch + chirp

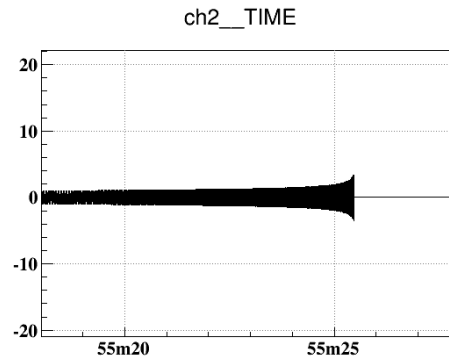
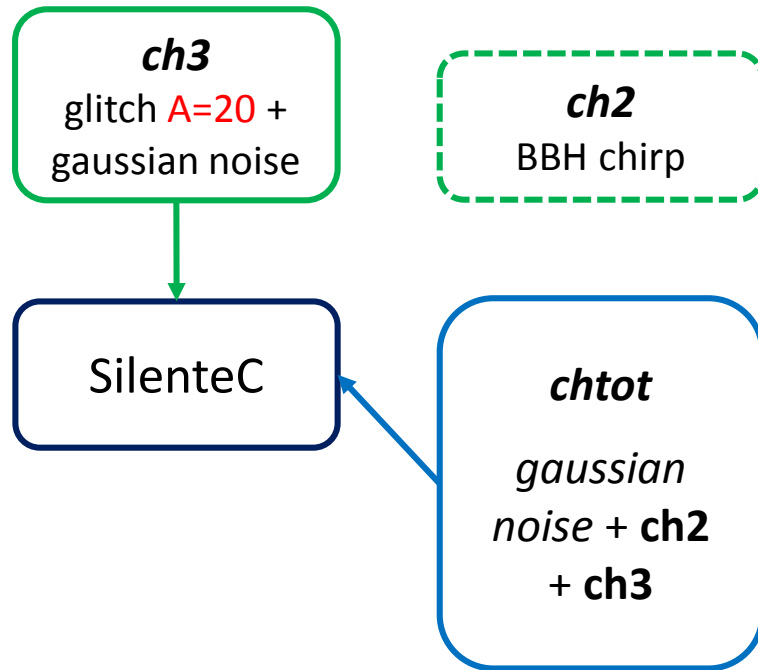

1112223334.0000 : Apr 4 2015 22:55:18 UTC

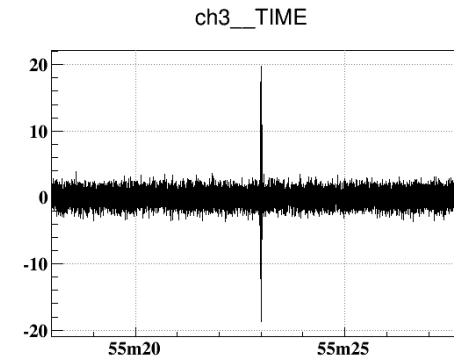

1112223334.0000 : Apr 4 2015 22:55:18 UTC

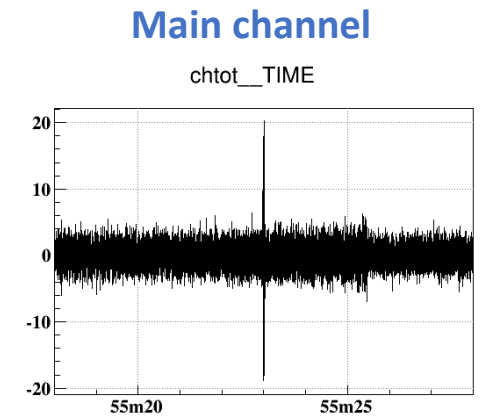

1112223334.0000 : Apr 4 2015 22:55:18 UTC

glitch + chirp

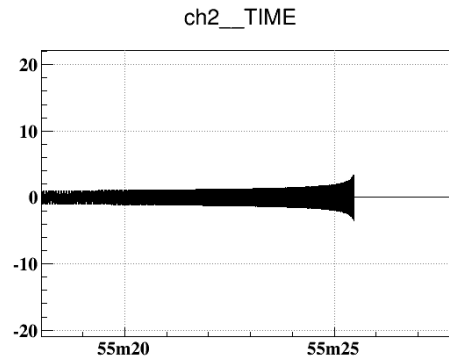
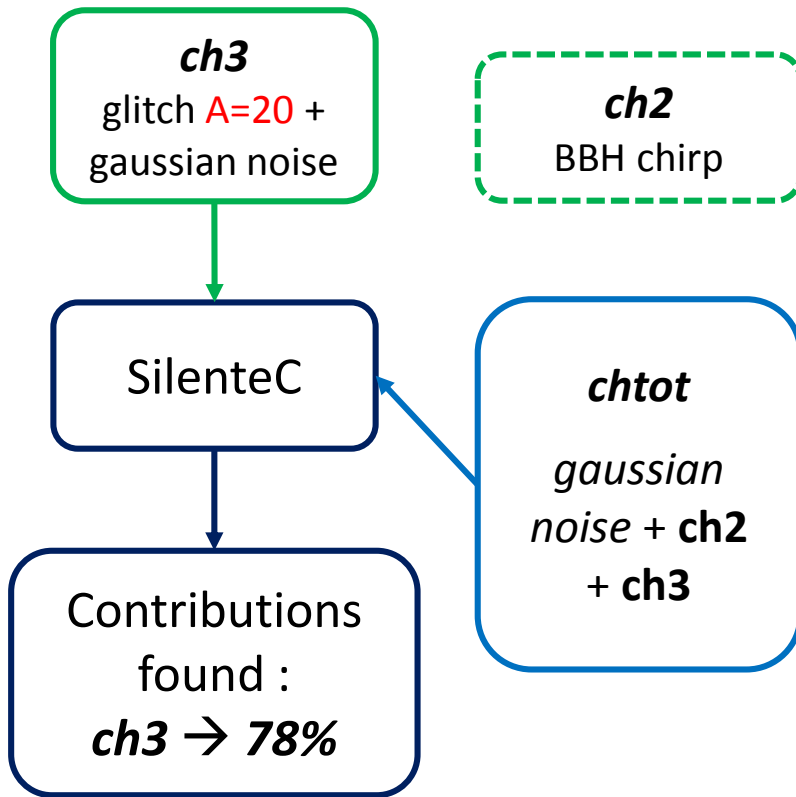

1112223334.0000 : Apr 4 2015 22:55:18 UTC
DQ_SilenteC_chtot_auxch_contrib__TIME

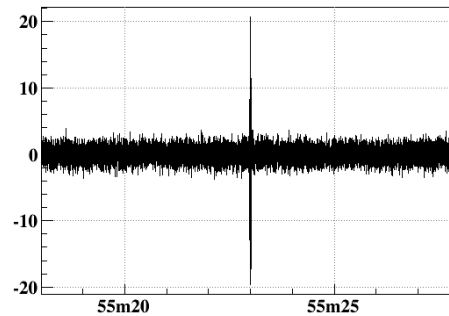

1112223334.0000 : Apr 4 2015 22:55:18 UTC

Contributions

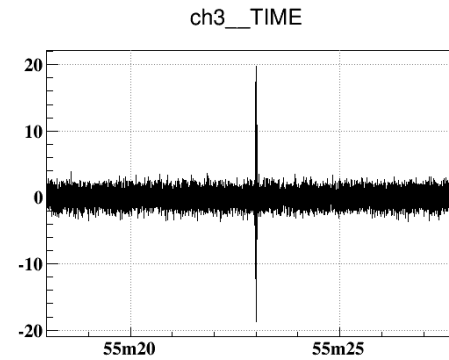

1112223334.0000 : Apr 4 2015 22:55:18 UTC
DQ_SilenteC_chtot_glitch_removed__TIME

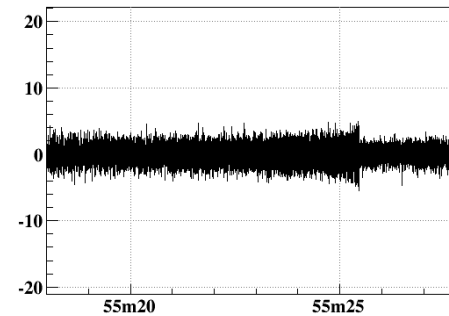

1112223334.0000 : Apr 4 2015 22:55:18 UTC

Cleaned channel
(Main ch. - Contrib.)

Main channel

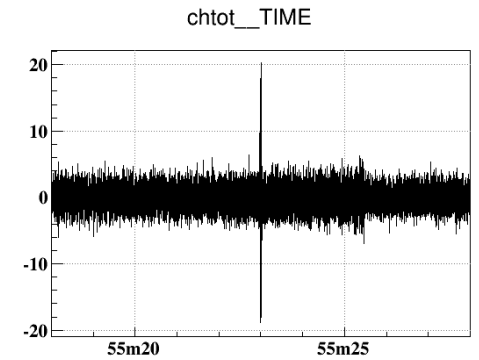

1112223334.0000 : Apr 4 2015 22:55:18 UTC

glitch + chirp

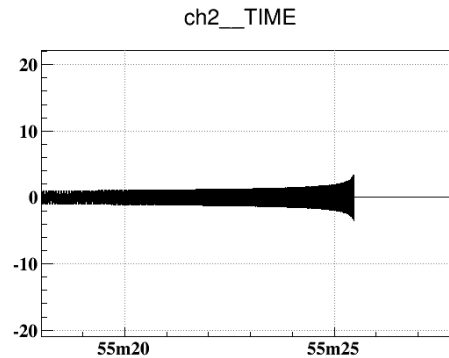
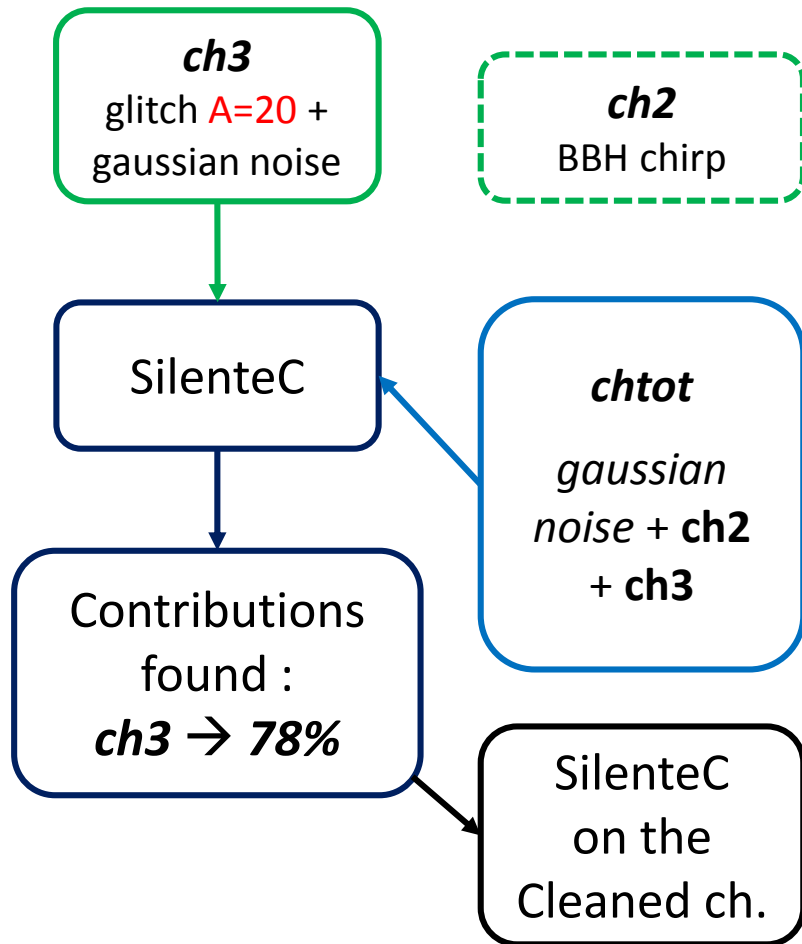

1112223334.0000 : Apr 4 2015 22:55:18 UTC
DQ_SilenteC_chtot_auxch_contrib__TIME

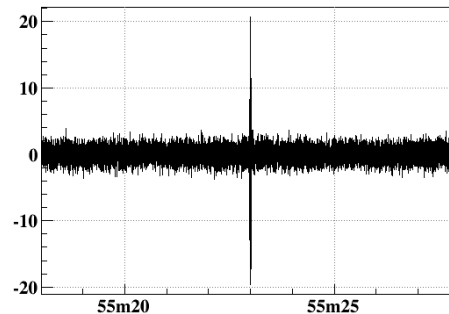

1112223334.0000 : Apr 4 2015 22:55:18 UTC

Contributions

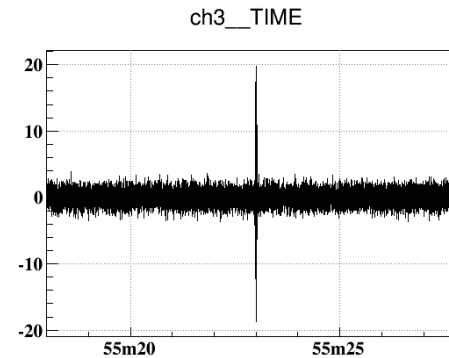

1112223334.0000 : Apr 4 2015 22:55:18 UTC
DQ_SilenteC_chtot_glitch_removed__TIME

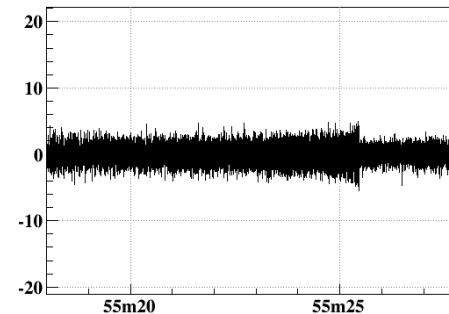

1112223334.0000 : Apr 4 2015 22:55:18 UTC

Cleaned channel
(Main ch. - Contrib.)

Main channel

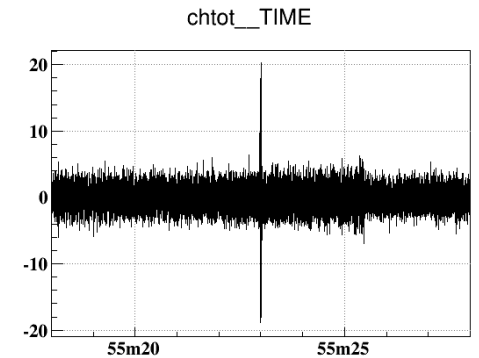

1112223334.0000 : Apr 4 2015 22:55:18 UTC
DQ_SilenteC_DQ_SilenteC_chtot_glitch_removed_glitch_removed__TIME

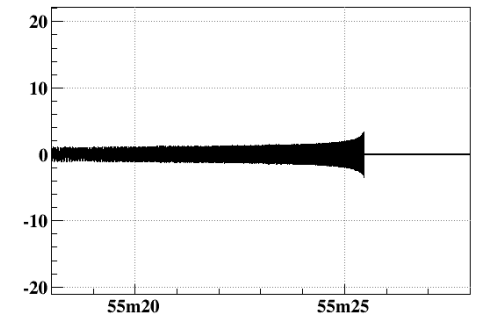

1112223334.0000 : Apr 4 2015 22:55:18 UTC

Residuals
(Cleaned ch. - gaussian noise)

Zoom: glitch + chirp

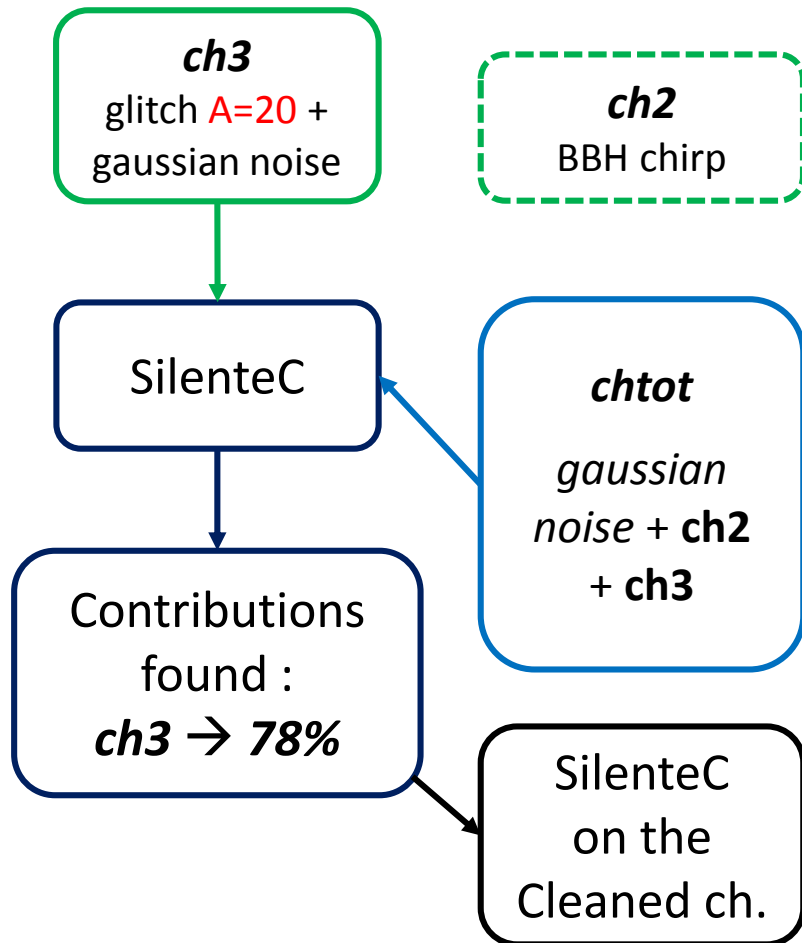

Main channel

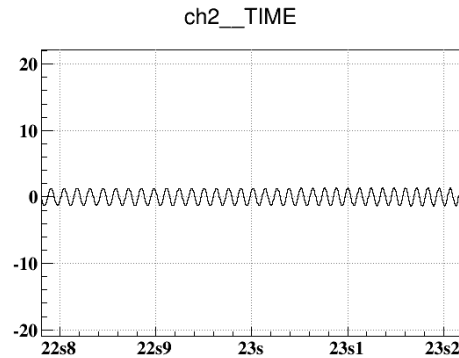

1112223338.7800 : Apr 4 2015 22:55:22 UTC

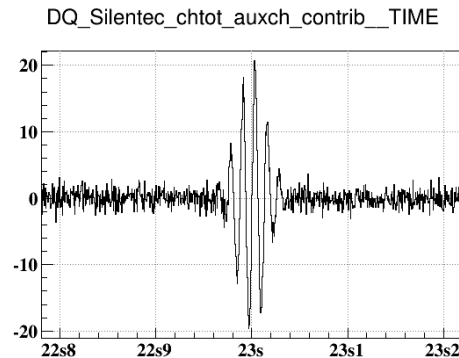

1112223338.7800 : Apr 4 2015 22:55:22 UTC

Contributions

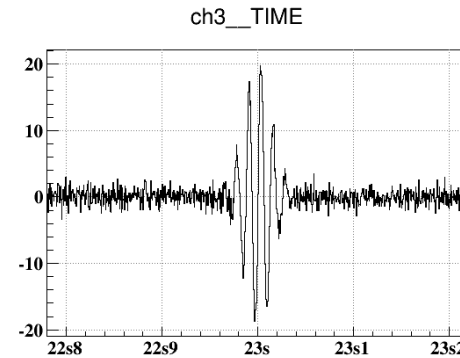

1112223338.7800 : Apr 4 2015 22:55:22 UTC

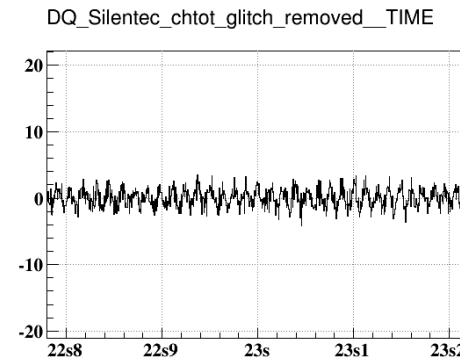

1112223338.7800 : Apr 4 2015 22:55:22 UTC

Cleaned channel
(Main ch. - Contrib.)

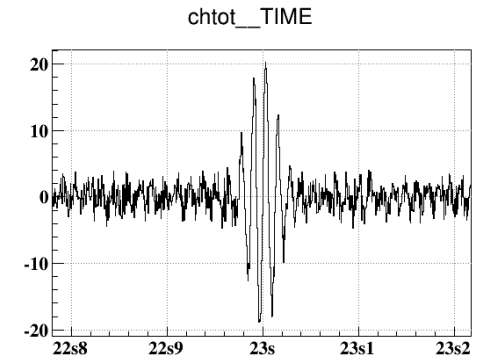

1112223338.7800 : Apr 4 2015 22:55:22 UTC

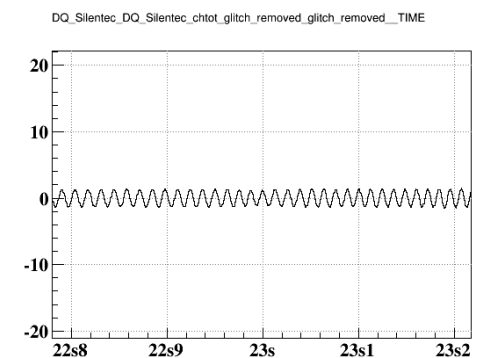

1112223338.7800 : Apr 4 2015 22:55:22 UTC

Residuals
(Cleaned ch. - gaussian noise)

Next steps

- Validate and tune the method on simulations of short glitches
 - Parameters: **window size, list of aux. channels, ...**
 - Understand/fix observed bias of aux. channels contributions
 - Check the safety: using **injections & MDCs** (gaussian/recolored noise)
 - Tests with transfer functions from aux. channels to main channel:

$$chtot = \sum_i TF_i(ch_i)$$

- Test the **computational efficiency**
 - Estimate speed, CPU and memory usage → “online”